

3D Lift Plan Manual

Rev. 4 10/21/09

Index

Introduction	Page 3
About 3DLiftPlan	Page 4
Current Features and Benefits	Page 5
Minimum Requirements	Page 6
Creating an Account	Page 7
My Account Page	Page 8
Getting Started	Page 9
Installing the Flux Player and Flux Player Controls	Page 10
Adding Cranes	Page 11 – 12
Editing Account Information	Page 13
Corporate Account	Page 14-17
Setting Preferences	Page 18
Managing, Opening, Creating Lift Plans	Page 19
Lift Plan Settings Page	Page 20
Quick Lift Setup	Page 21-22
Crane Search Setup	Page 23-25
Crane Search	Page 26
Crane Search Results	Page 27
Advanced Lift Setup	
• Load Type, and Load Details	Page 28-29
• Rigging Type and Rigging Details	Page 30-38
• Jobsite Obstructions	Page 39-48
○ Box	Page 42
○ Cylinder	Page 43
○ Sphere	Page 44
○ Construction Building	Page 45
○ Rope	Page 46
○ Text	Page 47
○ 3D Object Obstruction	Page 48
Choose Crane	Page 49
Lift Simulation	Page 50
Dimensions	Page 51-54
Load Chart	Page 55
Printing Page	Page 56
3D Lift Plan Publisher	Page 57

Printing Lift Plans to Paper or for Emailing to a Customer	Page 58
Critical Lift Plan Worksheet	Page 59
Tower Crane Planning	Page 60
Ground Bearing Pressure	Page 61
Crane Setup	Page 62
CAD Export	Page 63-64
Multi-Crane Lift	Page 65-70
Share Feature	Page 71-72
Snapshot Feature	Page 73-74
Manual Lift Video	Page 75-78
Technical Support & FAQ's Information	Page 79
Upcoming Features	Page 80

Introduction

Welcome to 3DLiftPlan.com and thank you for using our product. 3Dliftplan.com is the only lift planning application that uses the newest true 3d technology. This is not a CAD based program, so there is no need to buy an expensive additional program to use it, nor the expensive training or wasted time trying to draw objects. We have easy tools to draw many objects for your jobsite. You can use a combination of them to create detailed drawings or just keep it simple with our pre loaded objects.

This comprehensive manual is designed to help you use our site, to better understand how to navigate the site and produce high quality and professional lift plan.

The manual will be updated often as we develop and implement new features; I hope you find it useful, and complete.

Please let us know if there is any thing that requires more explanation or clarification.

Thanks for using 3dliftplan.com!

About 3DLiftPlan.com

Frequently Asked Questions

Why 3D Lift Plan?

- 3D Lift Plan's step-by-step design allows you to create detailed, accurate lift plans in minutes. With state-of-the-art 3D graphics and a powerful crane selection algorithm, 3D Lift Plan is the easiest to use and most powerful lift planning application available.

Why online lift planning?

- It is easily accessible from any location.
- Program features, load charts, and crane graphics are all updated on our server, so there is no need for you to install updates.

How much does it cost?

- All Link-Belt cranes are provided by Link-Belt at no charge.
- Other cranes can be purchased online from one week to one year at a time. Create an account to see the prices of the cranes in your fleet.

Can I use my entire fleet in 3D Lift Plan?

- Yes, you can use as many or as few cranes as you wish.
- We have over 500 cranes to choose from. If we don't have one of your cranes in our database, we can add it at no additional charge.
- [View the complete list of cranes available on 3D Lift Plan.](#)

Do I need to know CAD?

- No, 3D Lift Plan does not use any CAD-based program.

Do I need any special training to use 3D Lift Plan?

- No, you just need to know how to browse the internet and perform basic windows operations.
- We can provide training if you feel it would increase productivity for you or your company.

Does 3D Lift Plan work with metric units?

- Yes, you can choose to work in US or Metric units.

What does my computer require?

- Pentium III-class 600 MHz processor
- Hardware-accelerated 3D graphics card with at least 32MB of video memory
- DirectX version 9 (or newer)
- An X3D browser plugin. We recommend the [Flux Player](#).
- Internet Explorer v6 (or newer)

What is the relationship between 3D Lift Plan and Link-Belt?

- Link-Belt sponsors all of their cranes in 3D Lift Plan at no charge to the customer.

Current Features of 3DLiftPlan.com

Features and Benefits of 3D Lift Plan

Convenient

- Runs online in your web browser, accessible from any location.
- Cranes can be added in seconds. You don't need to wait days or weeks for an installation for all your pc's.
- You will always have the latest version, no need for you to install updates.
- Safe and secure storage of lift plans on the 3D Lift Plan server.

Easy-to-Use

- Doesn't require CAD or any other expensive program to run.
- User-friendly, step-by-step design makes 3D Lift Plan easy enough for a novice to use.
- Easy to move back and forth through the program to make changes.

Affordable

- Link-Belt cranes are provided by Link-Belt at no charge.
- Purchase other cranes for as little as one week, paying for just the time you need.

3D Graphics

- Highly-accurate graphics are in true 3D, allowing you to view the lift plan from any angle.
- Easy to create detailed 3D jobsites and rigging designs.
- Change ground and skyline colors.

Lift Simulation

- Performs a simulation of your lift while monitoring the crane's capacity.
- Allows you to view the load chart to see the capacity at various distances.

Crane Selection

- Searches your entire fleet of cranes in seconds.
- Displays the most economical crane configurations that can handle your lift at the top of the results list, allowing you to save time sifting through long lists of possible choices.
- Accounts for any obstruction in your jobsite whether it's to the side, front, rear, or above the crane.
- Provides several filter options so you can search only the cranes and configurations you choose.

Print Detailed Lift Plans

- Print your lift plan from any viewpoint.
- Quickly add notes to the printout.
- Show your logo on the printout.

Minimum Requirements

Pentium III-class 600 MHz processor

Hardware-accelerated 3D graphics card with at least 32MB of video memory

DirectX version 9 (or newer)

Flux Player Browser Plug in

Internet Explorer v6 (or newer)

Creating an Account



Click the Button Create a New Account

New Account
To create a new account fill out all the fields below, read and agree to the terms of the User Agreement, then press 'Submit'.

User Name:	<input type="text"/>
Password:	<input type="password"/>
Confirm Password:	<input type="password"/>
E-Mail Address:	<input type="text"/>
First Name:	<input type="text"/>
Last Name:	<input type="text"/>
Company Name:	<input type="text"/>
Phone Number:	<input type="text"/>
Address Line 1:	<input type="text"/>
Address Line 2:	<input type="text"/>
Address Line 3:	<input type="text"/>
Country:	<input type="text"/>

Website Application User Agreement

THIS LICENSE AGREEMENT CONSTITUTES A CONTRACT BETWEEN YOU AND A1A Software LLC. ('A1A') FOR USE OF 3DLIFTPLAN.COM. READ THIS AGREEMENT CAREFULLY BEFORE USING 3DLIFTPLAN.COM. IF YOU DO NOT AGREE WITH ALL THE TERMS AND CONDITIONS OF THIS AGREEMENT, PLEASE DISCONTINUE USE OF 3DLIFTPLAN.COM . IF YOU DO NOT AGREE TO THE TERMS AND CONDITIONS OF THIS AGREEMENT, YOU MAY NOT USE, COPY, TRANSFER, OR OTHERWISE EXPLOIT 3DLIFTPLAN.

DEFINITIONS. As used in this Agreement, 'You' and 'Your' refers to any person or entity acquiring or using the Website under the terms of this Agreement.

LOGIN/LICENSE. A1A grants to You a nonexclusive, nontransferable License to use the website. You may use the website to create lift plans, view load charts, simulate the lift and find the right crane for the lift you need to perform. You may make reasonable copies thereof to support the use of such crane provided that You shall only make exact copies of the documentation as originally provided and that You shall ensure that each copy contains all titles, trademarks, and copyright and restricted rights notices as in the original. Your login will be registered to you and only you. You are not permitted to share your login with any other person or entity. Sharing your login information could result in the loss of your login, stored information and any and all purchases you have made associated with the login.

I agree to the terms of this agreement.

Select a Username, password and fill in all of your contact information.

Make sure you read all of the Website Application User Agreement, check the box that your agree to the terms and click the submit button.

My Account Page

Use these links to add and edit your cranes in your account.

Use these links to set preferences, change your password or edit your account information

My Account
This is your main account page. Here you can edit your account information, create new Lift Plans, and load previously created Lift Plans.

My Account Getting Started Preferences Account Information Dispatch	My Cranes View My Cranes Add Cranes Remove Cranes Crane Groups Compare Cranes	Credits Credits: 1820 Purchase Credits Redeem Certificate
---	---	---

Create a new Lift Plan

Lift Plan Name:

Load a Lift Plan

Recent Lift Plans All Lift Plans

Click here to make 3D Lift Plan your default homepage.
To create a desktop shortcut to 3D Lift Plan, right-click and select "Create Shortcut".

	Name	Description	Customer
<input type="button" value="Open"/>	manual		
<input type="button" value="Open"/>	riggingplan1		
<input type="button" value="Open"/>	Multi-Tower Crane Plan		
<input type="button" value="Open"/>	tower	Pipe Bundle	XYZ Construction Engineers
<input type="button" value="Open"/>	HSC Rigging		
<input type="button" value="Open"/>	GE 15kw		
<input type="button" value="Open"/>	NFESC		
<input type="button" value="Open"/>	DualCrane	Two-Crane Lift	ABC Company
<input type="button" value="Open"/>	riggingplan		

News and Updates

Join us for online training!
Click here for the current schedule.

September 19, 2009 - Advanced Rigging
Advanced Rigging allows you to add any number of rigging components to your design, including shackles, master links, hooks, and lifting lugs.



You can specify weight, capacity, and size information for each rigging component, or choose items from rigging manufacturer catalogs.

September 18, 2009 - New Feature: Add Text to Jobsites

August 17, 2009 - Dispatch Now available! [View a Demonstration](#)
You can assign equipment, operators, and crews to jobs, schedule jobs including travel time, monitor permit requirements, view pending jobs for all cranes and employees, view past and future jobs for any customer,

Having problems viewing the 3D images on this website?
Check out the [3D Image Troubleshooting page](#).
3D Lift Plan supports Internet Explorer and Firefox.

Read the latest up to date news about 3dliftplan.

Create, Open and Delete Lift Plans.

Getting Started

Getting Started

This page will walk you through the basic steps required to create a lift plan. You can return to this page at any time by clicking the "Getting Started" link on your account page or under the "Support" menu option.

Step 1 - Create an account

- On the home page, click the "Create a new account" button and fill out the form that appears on the screen. Be sure to write down your password and keep it in a safe place. Your username and password are required every time you log on to 3D Lift Plan.
- You will access the features of 3D Lift Plan from the "My Account" page, which you can reach by clicking the "My Account" link at the top of the page.

Step 2 - Install the Flux Player

- The Flux Player by Media Machines is a free browser plugin that displays the 3D images.
- [Click here to install the Flux Player](#)
- *Note to Windows 98/Me Users:* The Flux Player uses the Microsoft XML libraries (MSXML) to load XML-encoded X3D files. These libraries may not be installed on your system. [Click here to download MSXML](#).
- If you have any problems installing the Flux Player or viewing 3D Images on the website, please visit this page: [Troubleshooting \(3D Images\)](#)

Step 3 - Add cranes to your account

- From the "My Account" page, select "Add Cranes".
- Select all of your Link-Belt cranes in the list, then press "Add to Shopping Cart". Note: All Link-Belt cranes are free of charge.
- Then select all of your other cranes in the same manner, changing the "Crane Make" to see a list of other manufacturer's cranes.
- Once you have added all of your cranes to the shopping cart, press "Purchase Cranes".

Step 4 - Create a new Lift Plan

- From the "My Account" page, enter a name for your new lift plan and press "Create New Lift Plan". This name will help you identify your lift plan if you want to make any changes to it after you close it.
- Your lift plan will automatically be saved every time you navigate to a different page of the website, so there is no need to manually save a file.
- When you want to load a lift plan later, you can find it in the "Load a Lift Plan" table at the bottom of the "My Account" page.

Step 5 - Design your Lift Plan

- 3D Lift Plan will guide you through the steps required to design your lift plan, just follow the instructions at the top of each page.
- Generally, you will fill out the information on each page and press the "Next" button to go to the next step.
- The navigation bar on the left side of the page allows you to go back to any step to make changes. Please note, if you make changes to the load or jobsite you will need to perform the Crane Search again to account for the changes you made.

Further Assistance

- If you need further assistance, please press the "Support" button at the top of the page.

Installing and Using the Flux Player

Install the Flux Player

- The Flux Player by Media Machines is a free browser plugin that displays the 3D images.
- [Click here to install the Flux Player](#)
- *Note to Windows 98/Me Users:* The Flux Player uses the Microsoft XML libraries (MSXML) to load XML-encoded X3D files. These libraries may not be installed on your system. [Click here to download MSXML](#).
- If you have any problems installing the Flux Player or viewing 3D Images on the website, please visit this page: [Troubleshooting \(3D Images\)](#)



Left click on the Explore button to activate this control. Put mouse pointer in the picture and hold your left mouse key down while moving your mouse. This will allow you fly around the jobsite. Hold down your right mouse key while moving your mouse around to pan around your jobsite, holding down your shift key at the same time will pan faster. You can also use your arrow keys.

Left click on the Examine button to activate this control. Put mouse pointer in the picture and hold your left mouse key down while moving your mouse. This will allow you to see the jobsite in 3D at any angle. Hold down your right mouse key while moving your mouse around to pan around your jobsite. You can use the center wheel on your mouse to zoom in and out.

Use the level button to straighten your jobsite and move it to the upright position.

Left click inside the viewpoint box to view and select all the default points of view. Or you can left click on the arrows on either side to change to each viewpoint.

Adding Cranes

My Account - Add Cranes

Select cranes to purchase

Crane Make: Terex-Demag

Crane Model:

- [Tier 3] AC 25
- [Tier 3] AC 50-1
- [Tier 4] AC 80-1
- [Tier 3] AC 80-2
- [Tier 4] AC 120
- [Tier 4] AC 155
- [Tier 4] AC 160-1
- [Tier 4] AC 180
- [Tier 3] AC 180 - Luffing
- [Tier 4] AC 250-1

Please email support@3dliftplan.com if you can't find your crane on this list.

Time to Purchase:

7 Days
 30 Days
 90 Days
 180 Days
 365 Days

[Add to Shopping Cart](#)

Shopping Cart

	Price	Days	Crane
Remove	Free	---	Link-Belt 138 HSL (Angle Boom)
Remove	Free	---	Link-Belt 218 HSL
Remove	Free	---	Link-Belt HTC-8690
Remove	\$475.00	365	Grove GMK5120
Remove	\$750.00	365	Grove GMK5165
Remove	\$50.00	365	Grove RT59S
Remove	\$150.00	365	Grove RT750E
Total:	\$1,425.00		

[Purchase Cranes](#)

Price List

	7 days	30 days	90 days	180 days	365 days	Link-Belt Preferred
Tier 1:	\$20	\$20	\$20	\$30	\$50	\$0
Tier 2:	\$20	\$20	\$35	\$60	\$100	\$0
Tier 3:	\$20	\$25	\$55	\$90	\$150	\$0
Tier 4:	\$20	\$35	\$90	\$150	\$250	\$0
Tier 5:	\$20	\$50	\$125	\$210	\$350	\$0
Tier 6:	\$25	\$70	\$175	\$285	\$475	\$0
Tier 7:	\$30	\$85	\$220	\$360	\$600	\$0
Tier 8:	\$40	\$110	\$275	\$450	\$750	\$0
Tier 9:	\$50	\$145	\$360	\$600	\$1000	\$0
Tier 10:	n/a	n/a	n/a	n/a	n/a	\$0

[Return to My Account](#)

We offer cranes from many different manufactures. Simply pick the manufacture from the drop down list and see all the cranes we have available for each one. You will also notice a tier number next to each model. These tier numbers help you determine the cost to use the model on 3dliftplan.com. For example, the Terex-Demag AC25 is a Tier 3 crane. If you look at the table to the left you will see Tier 3. You can purchase the use of the AC25 for 7 days to 365 days. If we want to use the AC25 for 30 days the price would be \$25.

Click "Purchase" to be transferred to our secure payment processing site.

If you would like to use a different payment method, contact 3D Lift Plan customer support at 904-430-0355.

[Purchase](#)

Order Number: 080805002

Total Price: \$150.00 (US Dollars)

Price	Days	Crane
\$150.00	365	Grove AT750B
\$150.00		





Click the purchase button to advance to the credit card entry form. If you would rather we send you an invoice for payment by check just call us or email us with your order number.

3D LIFT PLAN

Payment Details

Total Amount \$ 150.00
Description Cranes for 3D Lift Plan
All fields in bold are required.

Credit Card

Credit Card Type

Credit Card Number

Expiration Date

Billing Information

First/Last Name

Company

Street Address 1

Street Address 2

City/State/Postal Code

Country

Phone Number (nnn-nnn-nnnn)

Email Address

Order Number

[Buy](#)

Edit Account Information

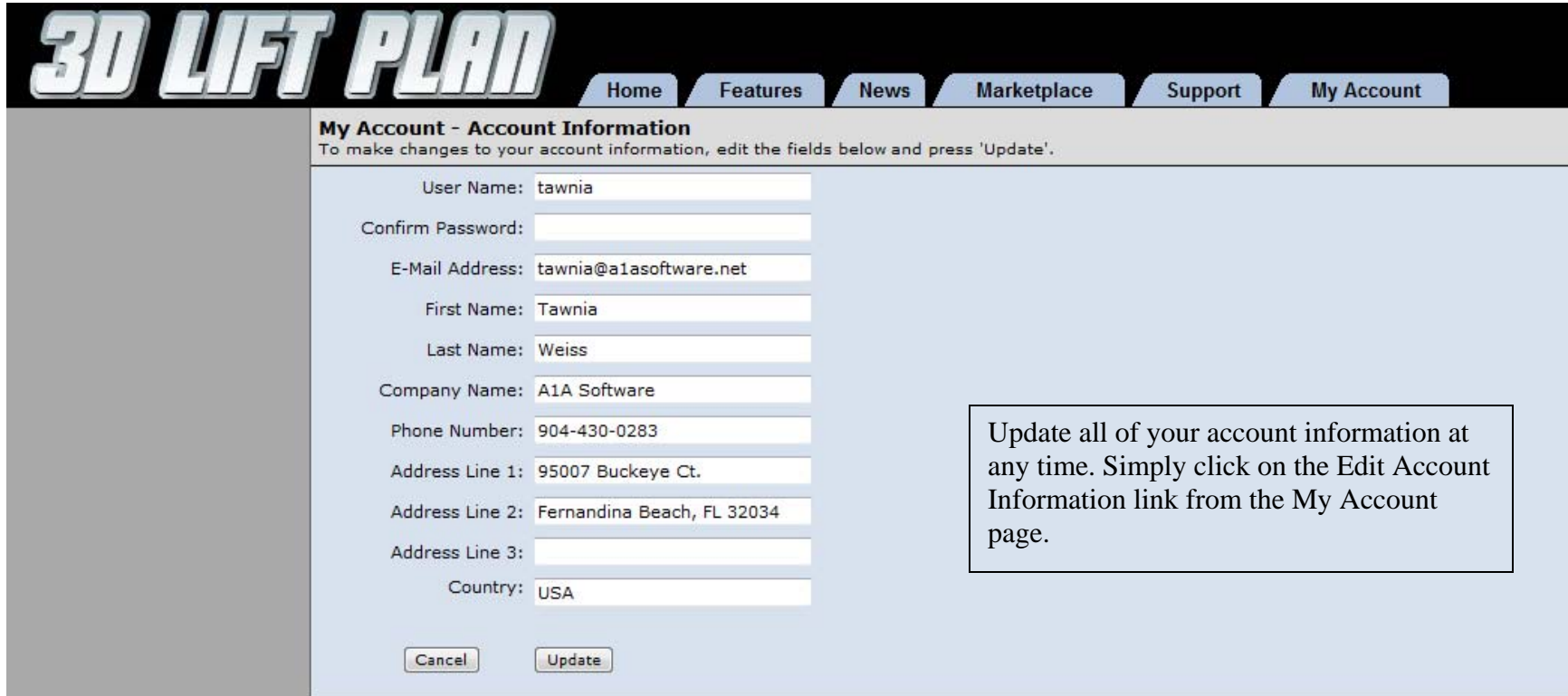

3D LIFT PLAN

Home Features News Marketplace Support My Account

My Account - Account Information
To make changes to your account information, edit the fields below and press 'Update'.

User Name: tawnia

Confirm Password:

E-Mail Address: tawnia@a1asoftware.net

First Name: Tawnia

Last Name: Weiss

Company Name: A1A Software

Phone Number: 904-430-0283

Address Line 1: 95007 Buckeye Ct.

Address Line 2: Fernandina Beach, FL 32034

Address Line 3:

Country: USA

Cancel Update

Update all of your account information at any time. Simply click on the Edit Account Information link from the My Account page.

Upgrade to a Corporate Account

Upgrade to a corporate account to access features like:

Tandem Lifts, Advanced Rigging, Copy Lift Plans, Change Crane Colors, Snapshot and Share Feature.

With a corporate account you can also share cranes, 3D objects, and lift plans between co-workers.

Corporate Account Information

Connect to a Corporate Account

If you would like to connect this account to a Corporate Account, enter the Corporate User Name provided to you by your account administrator.

Corporate User Name:

Upgrade to a Corporate Account

If you would like to convert this account into a Corporate Account, [click here](#).
(No changes will be made to your account when you click this link)

For more information about Corporate Accounts, [click here](#).

Click this link to upgrade to a corporate account

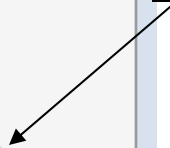

Corporate Account Cont'd

My Account - Purchase Corporate License	
Purchase Corporate License:	Your current license
<input checked="" type="radio"/> Purchase new Corporate License	Seats: ---
Option: <input type="radio"/> Extend my current Corporate License	Expires: ---
<input type="radio"/> Add more seats to my current Corporate License	Credits: 700
Account Type: <input checked="" type="radio"/> Shared Login	Corporate Account Pricing
<input type="radio"/> Individual Login	First two seats: \$250 each
Seats: 2	Seats 3-5: \$200 each
Your Order:	Seats 6-10: \$150 each
2 seats (365 days):	Seats 11-20: \$100 each
Your account will expire on 6/30/10	Additional Seats: \$50 each
Total Price: 7	
<input type="button" value="Cancel"/>	
<input type="button" value="Purchase"/>	
	<i>credits will be removed from your account.</i>

Corporate Account Cont'd

Corporate Account Information

Corporate Account Type: [Switch to 'Shared Login'](#)

Account Expiration Date:

Seats: [Update my corporate license...](#)

Share lift plans between all users.

Allow users to purchase 3D Objects with Administrator's credits.

User List:

To add users to your list, write them in the box above. Enter one user name per line, or separate them with commas. To remove a user from your list, simply delete their user name. When you are done, press 'Update'.

Login Statistics

	This Month	Last Month
Total number of User Logins:	1	1
Most users logged in at one time:	1	1
Number of times Seats were full:	0	0

[For more information about Corporate Accounts, click here.](#)

To allow user access to your corporate account have them create their own individual account and tell you their registered username so you can add it to this list. When you are done typing in their username click the "Update" button.

Corporate Account Cont'd

Corporate Account Information

Connect to a Corporate Account

If you would like to connect this account to a Corporate Account, enter the Corporate User Name provided to you by your account administrator.

Corporate User Name:

Upgrade to a Corporate Account

If you would like to convert this account into a Corporate Account, [click here](#).
(No changes will be made to your account when you click this link)

For more information about Corporate Accounts, [click here](#).

User accounts will enter the corporate account name here, then click submit.

Setting Preferences

Set all of the preferences you want to default to when using 3dliftplan.com.

3D LIFT PLAN Home Features News Marketplace Support My Account

My Account - Preferences
To make changes to your preferences, edit the fields below and press 'Update'.

Unit Preference: U.S.

Default Ground: Sand

Default Sky: Morning

Default View: Iso1

Texture Background: Yes No

Show XYZ-Axes: Yes No

Show Grid: Yes No

Graphic Size: Large

Graphic Width: 1000

Graphic Height: 575

Default Carrier Clearance (ft) 5

Default Boom Clearance (ft) 5

Default Rigging Clearance (ft) 5

Select whether you want to work in metric or U.S. units.

Select the default color and texture for the sky and ground color in your lift plans. Select whether you want to show the grid and xyz axis and what view you want for the default.

Select the size of you want the flux player window to be.

Specify the default clearances you want for running crane selection. For boom clearance you might want to make it a lower number like 2 so you will get more results when running crane selection.

Managing, Opening and Creating Lift Plans

The screenshot shows two main sections. The top section, titled 'Create a new Lift Plan', contains a text input field labeled 'Lift Plan Name:' and a button labeled 'Create New Lift Plan'. The bottom section, titled 'Load a Lift Plan', has two radio buttons: 'Recent Lift Plans' (selected) and 'All Lift Plans'. To the right of these buttons is a link 'Manage Lift Plans'. Below is a table with columns 'Name', 'Description', and 'Customer'. Each row in the table has an 'Open' button to its left.

	Name	Description	Customer
Open	liftplan1		
Open	MarginalWay		
Open	NFESC		
Open	NFESC3		

Create a new lift plan by simply typing in a name and left clicking the "Create New Lift Plan" button

Open an existing lift plan by left clicking the "Open" next to the lift plan you want to open.

The screenshot shows the 'My Account - Manage Lift Plans' section. It includes a warning: 'WARNING: Deleting a Lift Plan cannot be undone. Once you delete a Lift Plan, you will not be able to use it.' Below the warning is a link 'Return to My Account'. The main content is a table with columns 'Name', 'Description', and 'Customer'. Each row has a 'DELETE' button to its left.

	Name	Description	Customer
DELETE	liftplan1		
DELETE	NFESC2		
DELETE	NFESC		
DELETE	NFESC3		
DELETE	MarginalWay		

To delete a lift plan, left click on the "Delete" button next to the lift plan you want to delete.

Lift Plan Settings Page

The screenshot shows the 'Lift Plan Settings' interface with the following fields and controls:

- Lift Plan Name:** manual
- Description:** (empty text box)
- Customer:** (empty text box)
- Units:** U.S. (dropdown menu)
- Ground:** Sand (dropdown menu)
- Sky:** Morning (dropdown menu)
- View:** Iso1 (dropdown menu)
- Show Grid:**
- Show Grid Labels:**
- Jobsite Origin:** XZ Y
- Texture Background:**
- Show XYZ-Axes:**



Buttons at the bottom include: Previous Page, Update, Advanced Lift Setup, and Quick Lift Setup.

Callout boxes provide the following instructions:

- Put a Description in for your Lift Plan** (points to Description field)
- Give your Lift Plan a name** (points to Lift Plan Name field)
- Choose between US or Metric units** (points to Units dropdown)
- Enter a Customer name** (points to Customer field)
- Choose the Ground color for your plan** (points to Ground dropdown)
- Choose the Sky color for your plan** (points to Sky dropdown)
- Choose the default viewing position for the images as the appear on each screen** (points to View dropdown)
- Copy an Existing Lift Plan** (points to Import Lift Plan button)
- Choose whether you want to see the sky and ground textured** (points to Texture Background checkbox)
- Choose whether you want to see the XYZ axes markers and the grid** (points to Show XYZ-Axes checkbox)
- Once you have selected your crane you can return here to change the color of your crane. Some cranes cannot be changed.** (points to Change Crane Colors button)
- Choose the Advanced Lift Setup to add rigging and create an advanced jobsite.** (points to Advanced Lift Setup button)
- Use the Quick Lift Setup, answer a few questions then find the let 3dliftplan's crane selection find the best crane fast.** (points to Quick Lift Setup button)

For Instructions on the Advanced Lift Setup go to page 28

Quick Lift Setup Step 1

- How much weight are you lifting?
 lbs
- How high are you lifting?
 ft
- What shape is the object you are lifting?
  
- How big is the object you are lifting?
Length: ft
Width: ft
Height: ft

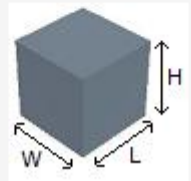
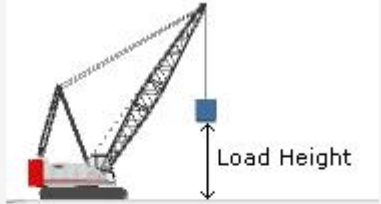

Answer a few simple questions about your lift to determine which crane you need for the job.

Quick Lift Setup Step 2

• Are you lifting above an obstruction?
 Yes
 No

Obstruction Height: ft
 Obstruction Length: ft
 Obstruction Width: ft
 Load Distance: ft
 Minimum Setup Distance: ft

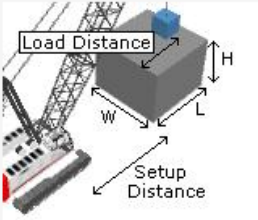

• Are you lifting above multiple obstructions?
 Yes
 No

• Enter the height and length of each obstruction:

	Height (ft)	Length (ft)
Obstruction #2:	<input type="text" value="0"/>	<input type="text" value="0"/>
Obstruction #3:	<input type="text" value="0"/>	<input type="text" value="0"/>
Obstruction #4:	<input type="text" value="0"/>	<input type="text" value="0"/>
Obstruction #5:	<input type="text" value="0"/>	<input type="text" value="0"/>

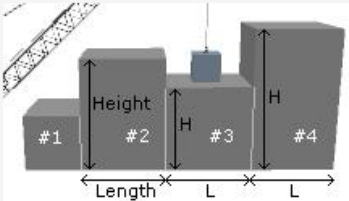

• Is there an obstruction behind the crane?
 Yes
 No

Distance to Rear Obstruction: ft
 Obstruction Height: ft
 Obstruction Length: ft
 Obstruction Width: ft

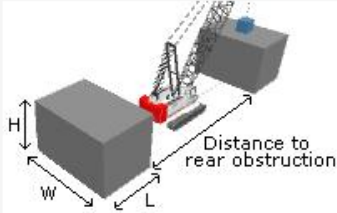

• Is there an obstruction to the left of the crane?
 Yes
 No

Distance to Left Obstruction: ft
 Obstruction Height: ft
 Obstruction Length: ft
 Obstruction Width: ft

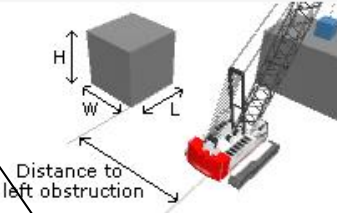

• Is there an obstruction to the right of the crane?
 Yes
 No

Add a front obstruction, and give it dimensions. Enter your load distance (distance from front edge of building to center of load), and enter your minimum setup distance (distance from center pin of crane to front edge of load.)

You can also enter multiple heights and depths for your front obstruction.

You can also enter obstructions in behind you or to the right or left of you. For the rear building how much room do you have between the 2 buildings? For the buildings to the left and right assume that your crane is going to be centered on the front obstruction. How far over to the left or right do you want the edge of the obstruction to start?

Crane Search Setup Page

Starting point for placement of center pin

Ending point for placement of center pin

Location of center pin from side to side

The red area represents the area in which the crane will be placed.

White Line Represents the location you want to place the center pin.

Crane Location	Load Location	Clearances
Min. Setup Distance (ft) 25	X (ft) 75	Carrier (ft) 5
Max. Setup Distance (ft) 500	Y (ft) 100	Boom (ft) 2
Z (ft) 0	Z (ft) 0	Rigging (ft) 5
Crane Height (ft) 0		

Back
Update
Next

The 3D visualization shows a perspective view of a jobsite with a grid floor. A red rectangular area is highlighted on the grid, representing the crane placement zone. A white line is drawn across the red area, indicating the center pin location. Several grey 3D blocks represent site obstructions. The grid floor is labeled with X and Z coordinates.

Controls to place the load on the jobsite, X is the position lengthwise on the jobsite. By choosing 5 the load will be placed starting at 5' from 0 on the X axis. Set Z to the location from side to side, and Y for the height you want to lift it.

Controls to set the clearance of the crane components to all your jobsite obstructions, for example if you had a power line you would want to set your boom clearance to 10 to make sure that when the program performs crane selection it choose a crane and configuration that is at least 10' away from the power line.

After creating your jobsite with the Quick Lift Setup feature or by manually adding jobsite obstructions, you can search your entire fleet of cranes to determine which ones can perform the lift.

Crane Search Setup

The Crane Search Setup page lets you set the position of the load at a critical point in the lift, and lets you set a range of possible locations for the crane.

Crane Location		Load Location		Clearances	
Min. Setup Distance (ft)	15	X (ft)	20	Carrier (ft)	5
Max. Setup Distance (ft)	60	Y (ft)	30	Boom (ft)	5
Z (ft)	0	Z (ft)	0	Rigging (ft)	5
Crane Height (ft)	0				

Load Location X and Z represent the center point of the load, relative to the jobsite origin. Load Location Y is the distance from the ground to the bottom of the load.

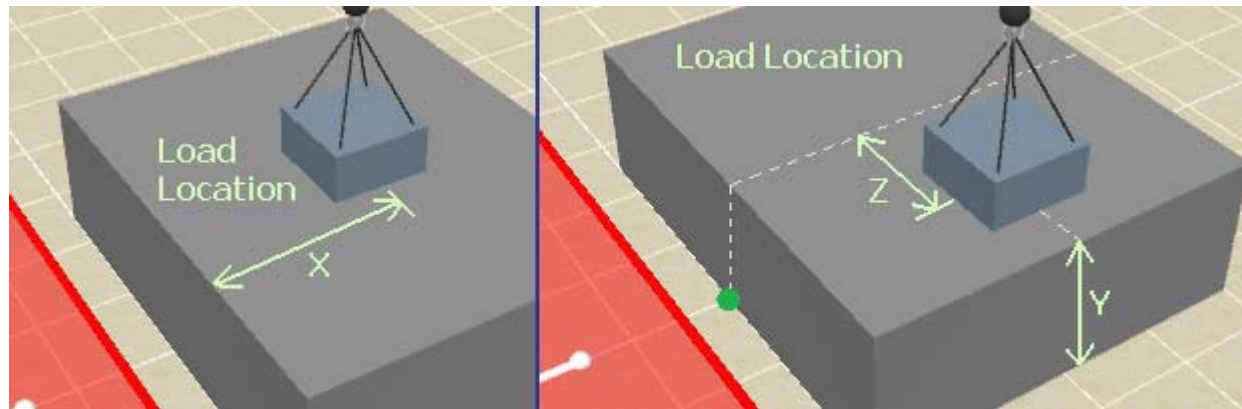

The Clearances box allows you to set minimum clearance requirements for various parts of the crane. A Carrier Clearance of 5 ft will ensure that the carrier of the crane is at least 5 ft away from all jobsite obstructions. A 5 ft Boom Clearance will keep the boom at least 5 ft away from all jobsite obstructions. Setting the Rigging Clearance to 5 ft will keep the Load and Rigging components at least 5 ft away from the boom or jib.

Setup Distance is the distance from the jobsite origin to the center pin of the crane. As an example, if you set the Minimum Setup Distance to 20 ft, the crane center pin will be positioned at least 20 ft from the primary obstruction.

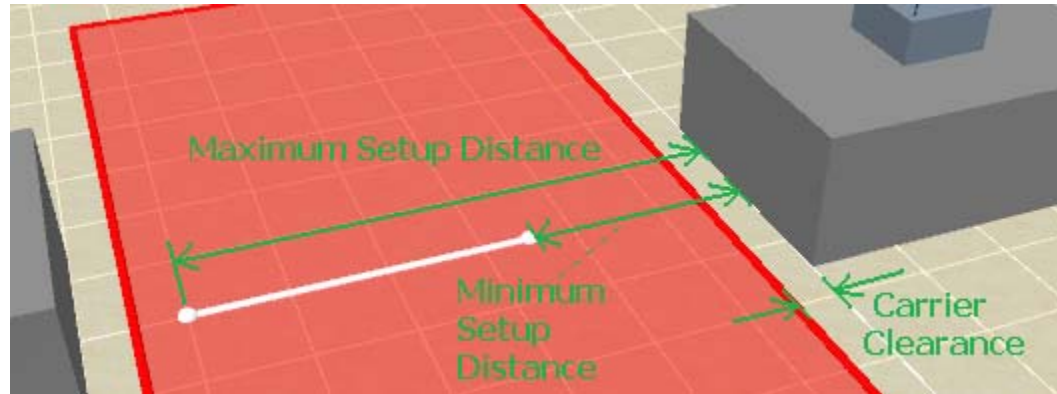

The 3D image helps represent the Crane Search parameters. The white line represents the range of the crane center pin location. The red area represents the allowable area for the crane carrier. In other words, the crane center pin will be placed somewhere on the white line, and the entire carrier of the crane will be placed inside the red area.

When you have set all the Crane Search Setup values, click Next to choose which cranes to search.

Search Cranes

The Search Cranes page lets you choose which cranes to search. You can also use the filters to narrow down which cranes and charts to search. In the Search Options box, there are two options to choose from...

- 1) "Find best result for each crane" - This option will find the optimal configuration for each crane, which typically means the least amount of counterweight and shortest possible boom and jib.
- 2) "Find multiple results for each crane" - Select this option if you would like to see multiple configurations for each crane.

When you are done selecting which cranes to search, click Next to perform the search.

Results

The results page lists all the cranes that can perform the lift. Information about the load chart and crane configuration are provided in the table. Click the "Use This Chart" button next to the chart you would like to use. The crane will be automatically set up and you will be sent to the Lift Simulation page.

If you don't see any results, go back through the Search Setup steps to try to broaden your search. Try searching more cranes, selecting fewer filters, decreasing clearance requirements, and increasing the range of possible setup distances.

Search Crane Page

Select the cranes you would like to run crane selection on.

Cranes to Search

Filter: Link-Belt

- Link-Belt 218 HSL
- Link-Belt 218 HSL - Auxiliary Tip Extension
- Link-Belt 218 HSL - Luffing
- Link-Belt 238 HYLAB 5
- Link-Belt 238 HYLAB 5 - Luffing
- Link-Belt 248 HYLAB 5
- Link-Belt 298 HSL
- Link-Belt 298 HSL - Horsehead Tip Extension
- Link-Belt 298 HSL - Luffing
- Link-Belt 308 HYLAB 5
- Link-Belt 348 HYLAB 5
- Link-Belt 348 HYLAB 5 - Luffing
- Link-Belt ATC-822
- Link-Belt ATC-3130
- Link-Belt ATC-3130 Series II
- Link-Belt ATC-3200

0 cranes are selected.

Select All Select None

Search Filters

Minimum Tonnage: 0

Maximum Tonnage: 9,999

- Search Telescopic cranes
- Search Lattice cranes
- Search jib charts
- Search charts On Tires
- Search charts On Outriggers
- Search charts On Crawlers
- Search restricted range charts (Over Rear, Over Side, etc)

Search Options

Chart Deduction: 75%

- Find best result for each crane
- Find multiple results per crane

Back Next

Select whether you would like to include or exclude different charts

Select the minimum percentage of chart you want to use.

Select whether you want to find the best result for each crane that can perform the lift or find multiple results from each crane.

Search Result Page

3D LIFT PLAN

Logged in as Demo1
Logout

Home
Features
News
Support
My Account

Settings
Lift Plan Settings

Lift Setup
Load Type
Load Dimensions
Rigging Type
Rigging Details
Obstructions
Choose Crane

Crane Search
Search Setup
Search Cranes
Search Results

Lift Plan
Dimensions
Load Chart
Lift Simulation
Print

Search Results

8 configurations were found that can perform your lift. Search Time: 3.0 seconds

Select one of the following load charts...

	Crane	Boom and Jib	Range and Base	Counterweight	Capacity	Lift Radius	Tip Height	Boom Angle
<input type="button" value="Use This Chart"/>	Link-Belt ATC-3200	114.8' Main Boom	360° Fully Extended Outriggers	112,435 lbs	71,400 lbs (100%)	49.5 ft	113.01 ft	62.1°
<input type="button" value="Use This Chart"/>	Link-Belt ATC-3250	111.9' Main Boom	360° 100% Outriggers	103,616 lbs.	73,200 lbs (103%)	49.5 ft	109.22 ft	61.1°
<input type="button" value="Use This Chart"/>	Link-Belt 298 HSL - Horsehead Tip Extension	130' Main Boom Horsehead Tip Extension	360° Crawlers	ABCDE+A	74,700 lbs (105%)	59.5 ft	131.18 ft	67.7°
<input type="button" value="Use This Chart"/>	Link-Belt 298 HSL	250' Main Boom (Open Throat Tube Boom)	360° Crawlers	AB+A	76,700 lbs (107%)	49.5 ft	254.21 ft	79.9°
<input type="button" value="Use This Chart"/>	Link-Belt 348 HYLAB 5	120' Main Boom (Heavy Duty Tube Boom)	360° Retracted Crawlers	AB+A	80,400 lbs (113%)	69.5 ft	109.81 ft	59.0°
<input type="button" value="Use This Chart"/>	Link-Belt 298 HSL - Luffing	110' Main Boom (Tube Boom) 90' Luffing Jib	360° Crawlers	ABCDE+A	75,400 lbs (106%)	67.5 ft	197.65 ft	80.0°
<input type="button" value="Use This Chart"/>	Link-Belt 348 HYLAB 5 - Luffing	130' Main Boom (Luffing Boom) 100' Luffing Jib	360° Retracted Crawlers	ABC+A	129,700 lbs (182%)	49.5 ft	232.46 ft	88.0°
<input type="button" value="Use This Chart"/>	Link-Belt 548 HSL	118.1' Main Boom (Heavy Duty Boom)	360° Crawlers	Full	216,400 lbs (303%)	65.1 ft	111.57 ft	62.8°

If you don't find a crane below or crane selection did not find any cranes left click on the back button and select different cranes, change clearances or change the location you selected for the center pin.

Left click on the button next to the crane you want to use.

If at any point you want to go back and make changes to your load, obstructions, or search setup simply click on the link you want.

****If you have not added cranes to your account there will be no cranes listed. Please make sure you return to the My Account page and open the Add Cranes link****

Advanced Lift Setup

Load Type Page

3D LIFT PLAN Admin

Home Features News Marketplace Services Support My Account

Settings
Lift Plan Settings

Lift Setup
Quick Lift Setup
Load Type
Load Details
Rigging Type
Rigging Details
Obstructions
Choose Crane

Crane Search
Search Setup
Search Cranes
Search Results

Lift Plan
Load Chart
Lift Simulation
Dimensions
Print
Export

ISO1

Load Type
Choose the shape of the object you are lifting.

Back

3D Object

Select the Load Type you want to use. You can select the 3D object to access all our custom objects like wind turbines, trees, beams and more. Once you left click on a load you will be taken to the next page where you can enter all the dimension information for the load.

Load Dimensions Page

Enter the weight of your load

Select the color you want the load to be

Rotate the load under the hook or angle your load. Then select whether you want the boom to stay at that angle when you swing the boom.

Select whether you want the load to rotate with the boom while you are swinging the boom. Or uncheck to keep load at the angle of the building you are setting it on.

Enter the Dimensions for the load

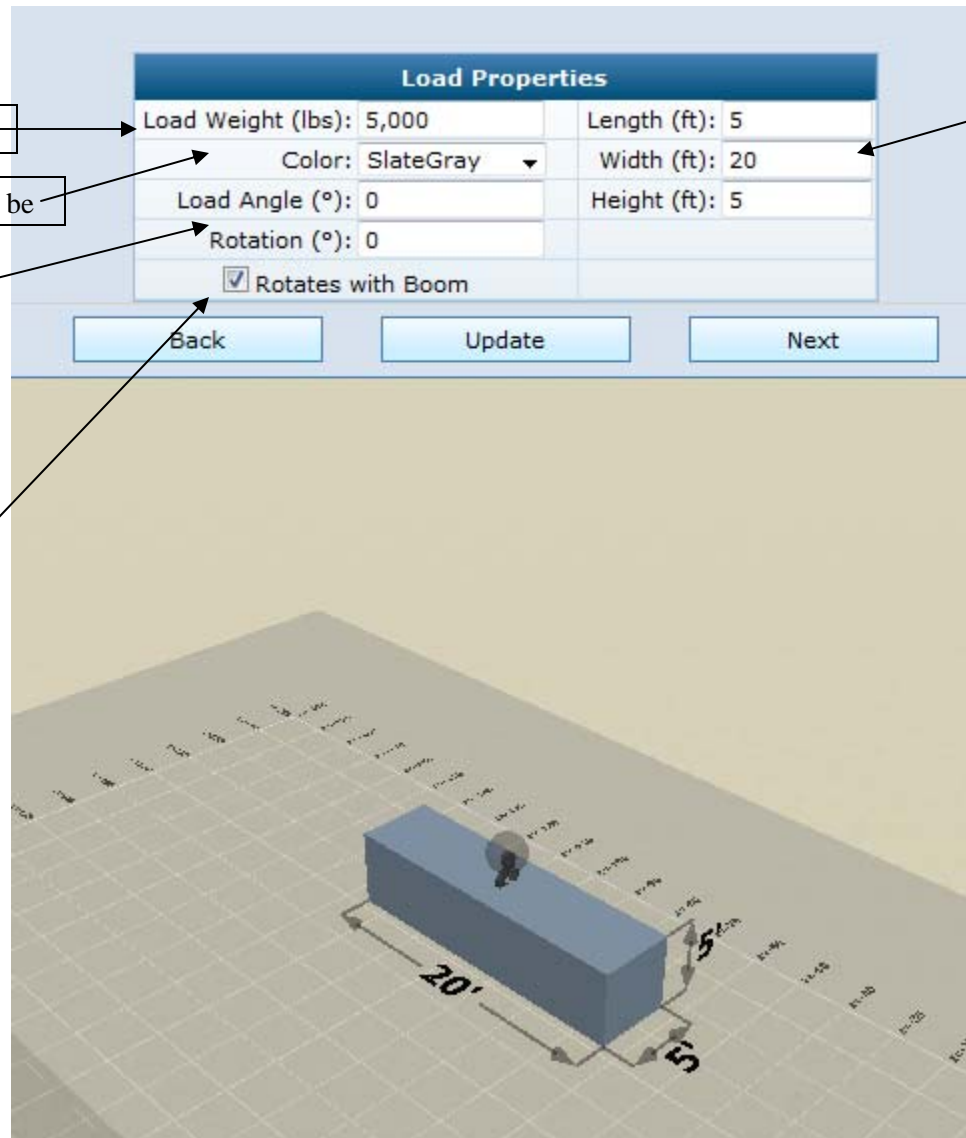

Rigging Type Page

Choose the rigging configuration that best represents your rigging setup.

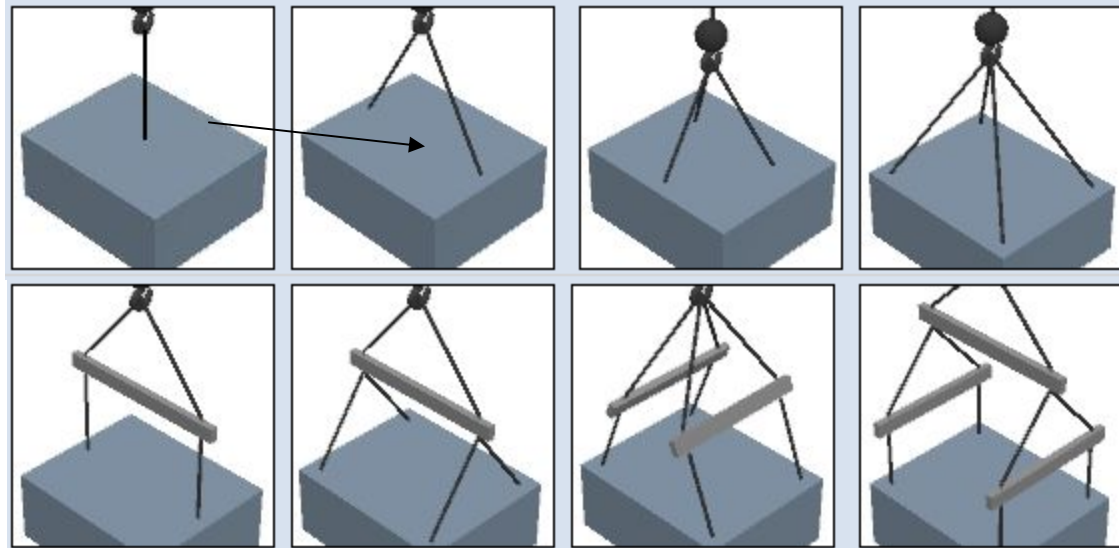

Rigging Offset Page

Introduction

By default, the load is centered directly below the hook. If you want to offset the load, you will need to modify the Rigging Offset values on the Rigging Properties page.

Rigging Offset	
Set to...	▼
X (ft):	0
Y (ft):	0
Z (ft):	0
Rotation (°):	0

Rigging Offset

The easiest way to offset the load is to choose a point from the "Set to" drop down box, such as "Top Right", "Top Back", or "Bottom Center". This will automatically position the load so the hook is directly above the point you choose. If you select a "Top" point, the pick points will be level with the top of the load. If you select a "Bottom" point, the pick points will be level with the bottom of the load.

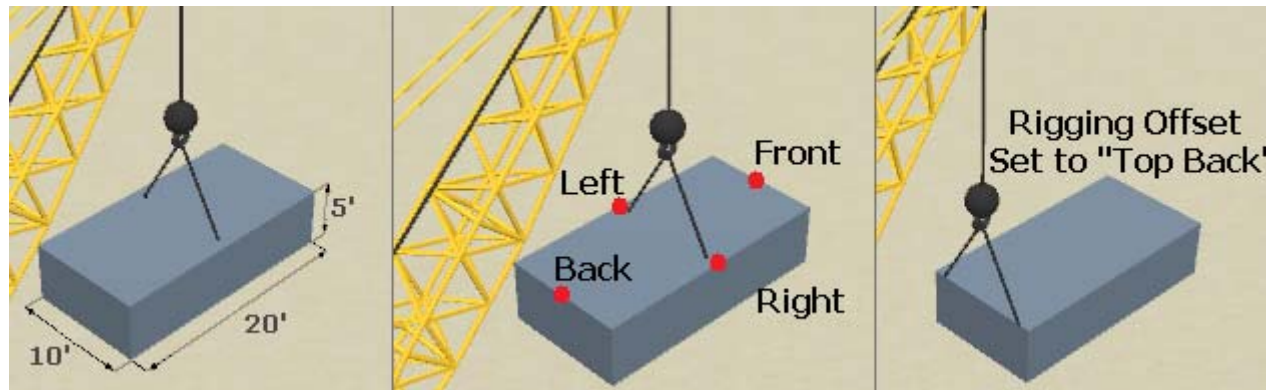

To offset the load to a different point, you will need to modify the X, Y, and Z values in the Rigging Offset box. To move the load forward or backward, modify the X value. A positive X value will move the load forward. A negative X value will move the load backward.

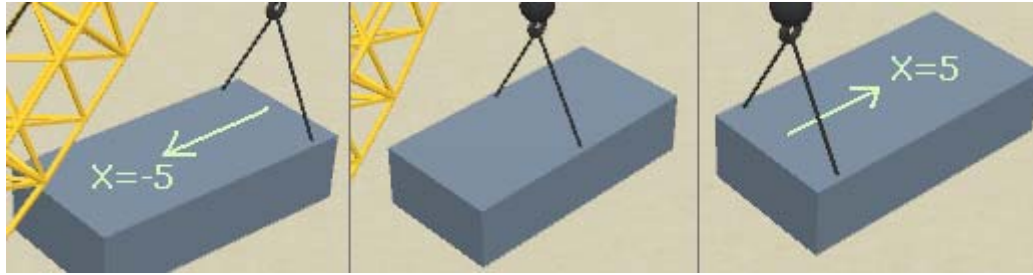

To move the pick points down to the side or bottom of the load, modify the Rigging Offset Y value.

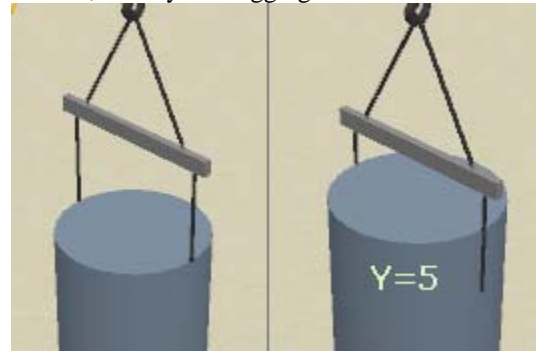

If you change the load angle or rotation (on the Load Details page), the coordinate axes also rotate. For instance, if you rotate the load 90 degrees, changing the Rigging Offset X value will now move the load left and right instead of forward and back. If you change the Load Angle to 90 degrees, the X-axis will be oriented vertically, so adjusting the Rigging Offset X value will move the pick points up and down.

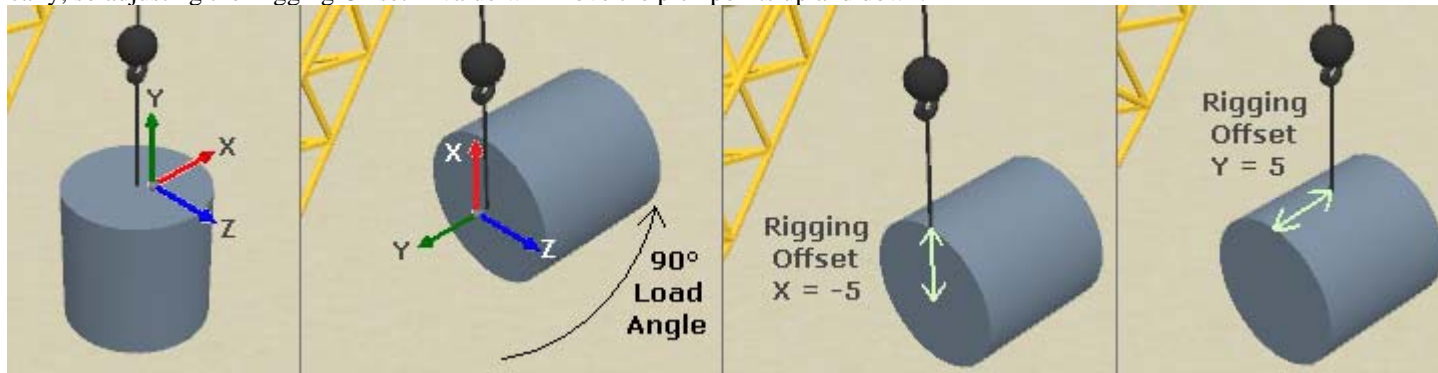

Load Rotation and Rigging Rotation

When you change the Load Rotation (on the Load Details page), the rigging also rotates with the load. To rotate the rigging objects without rotating the load, you should change the Rotation value on the Rigging Details page.

Load Rotation

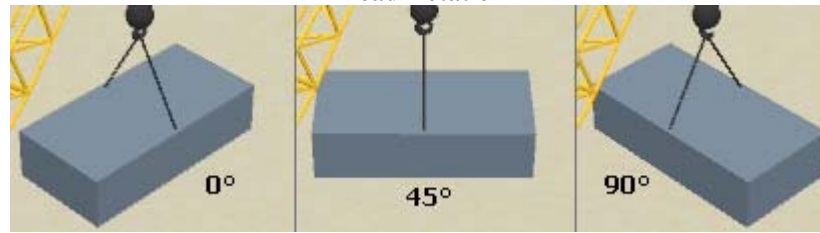

Rigging Rotation

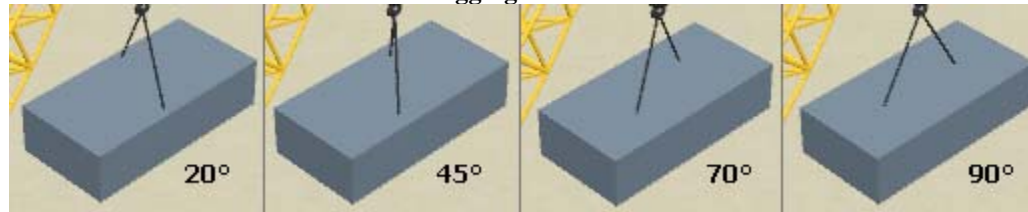

Rigging Details Page

4 Leg Bridle Setup

Select how many parts of line you need. When you select 1 you will have a headache ball. When you select multiple parts of line you will get a hook block and the total parts of line you selected.

Use our sling calculator to determine the length of your slings, the leg height or the angle of your slings. 3D Lift Plan will also calculate the sling tension.

Offset your rigging on the load. Refer to the previous page for instructions.

Enter the length of the slings you want to use and the distance between where you are planning on attaching your rigging to the load.

Enter in the weight of the rigging you are using.

You will notice the load that you selected and sized on the previous pages.

The screenshot shows a software interface for configuring a 4-leg bridle. It consists of several data entry panels and a 3D visualization.

Hoist Line	Rigging Offset	Slings
Parts of Line: 1	Set to...	Leg Length (ft): 18.25
Headache Radius (ft): 1.25	X (ft): 0	Leg Height (ft): 15.8
Headache Y (ft): 2	Y (ft): 0	Sling Angle (°): 60
	Z (ft): 0	
	Rotation (°): 0	

Sling Tension	Rigging Weights	Pick Points
Supporting Legs: 2	Load Line (lbs): 0	X-Distance between Pick Points (ft): 3
Sling Tension (lbs): 2,886.75	Block (lbs): 0	Z-Distance between Pick Points (ft): 18
	Hook (lbs): 0	
	Rigging (lbs): 0	
	Rigging: 0	
	Rigging: 0	

Buttons: Back, Update, Next

The 3D diagram below shows a blue rectangular load with dimensions 18' (length), 20' (width), and 5' (height). A hook is positioned above the load, with four slings extending from it to the corners of the top surface. The slings are labeled '18.2' @ 60°'. The distance between the attachment points on the top surface is 3'.

Spreader Bar Rigging Details

Hoist Line	Rigging Offset	Upper Slings	Pick Points
Parts of Line: 1	Set to... ▾	Leg Length (ft): 18	Distance between Pick Points (ft): 18
Headache Radius (ft): 1.25	X (ft): 0	Leg Height (ft): 15.59	
Headache Y (ft): 2	Y (ft): 0	Sling Angle (°): 60	
	Z (ft): 0		
	Rotation (°): 0		
Sling Tension	Rigging Weights	Lower Slings	Spreader Bar
Supporting Legs: 2 ▾	Load Line (lbs): 0	Leg Length (ft): 13	Length (ft): 20
Upper Sling Tension (lbs): 2,886.75	Block (lbs): 0	Leg Height (ft): 13	Width (ft): 0.5
Lower Sling Tension (lbs): 2,500	Hook (lbs): 0	Sling Angle (°): 90	Height (ft): 1
	Rigging (lbs): 0		Distance Between Upper Holes (ft): 18
	Rigging: 0		Distance Between Lower Holes (ft): 18
	Rigging: 0		Y-Distance to Upper Holes (ft): 0.25
			Y-Distance to Lower Holes (ft): 0.25

Back Update Next

Enter the dimensions for the spreader bar you are using. Then select the distance you need between where your slings attach to the upper and lower part of your spreader bar.

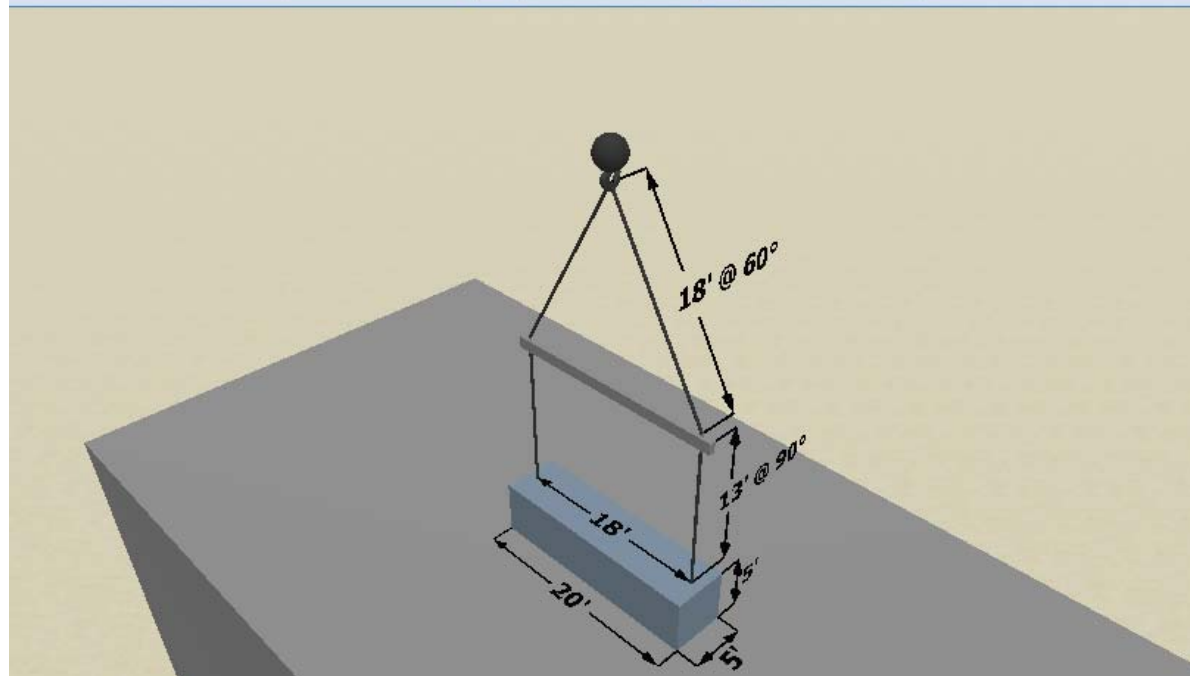

Advanced Rigging Feature

Select Rigging Leg

Hook ▾

Hook

Upper Slings

Spreader Bar

Lower Slings

Load

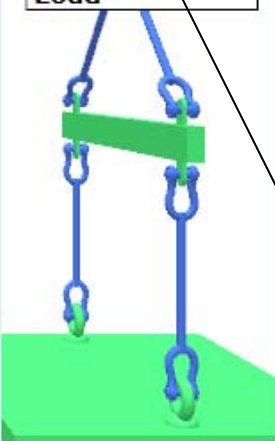

Rigging Components

Hoist Line	Parts of Line: 1
	Hook Height (ft): 135.09
	Headache Radius (ft): 1.25
	Headache Y (ft): 2
	Hoist Line Weight (lbs): 0
	Block Weight (lbs): 0
Hook	Name: Hook
	Size (ft): 0
	Weight (lbs): 0
	Capacity (t): 0
Add object...	▾
Add object...	▾
Add object...	▾

Sling Tension

Supporting Legs: 2 ▾

Upper Sling Tension (lbs): 2,886.75

Lower Sling Tension (lbs): 2,500



Click Here To Order

All Rigging Components

Item	Capacity (t)	Weight (lbs)	Qty	Total Weight (lbs)
Hook	-	-	1	-
Sling	-	-	2	-
Spreader	-	-	1	-
Sling	-	-	2	-
Total Rigging Weight:				0
Load	-	5,000	1	5,000
Net Load Weight:				5,000

Select what rigging you want to work with.

Hook- You can enter in the weight and capacity of your hoist line, hook and block. You can put rigging under your hook one at a time.

Slings- You can enter size of wire rope, capacity and weight. Y can add rigging to each end of the slings you have. If you have 2 slings it will add 2 rigging items at a time when you select to add them. 4 slings will add 4 rigging items at a time to either the upper or lower end of the slings.

Spreader Bar- You can enter weight, dimensions and capacity of your spreader bar.

Load- will add rigging items to the load.

Select Rigging Leg

Upper Slings



Rigging Components

Shackle

Name: Crosby S

Size (ft): 1

Weight (lbs): 0

Capacity (t): 0

Name: Slings

Length (ft): 17

Diameter (ft): 0.26

Weight (lbs): 0

Capacity (t): 0

Sling Tension

Supporting Legs: 2

Upper Sling Tension (lbs): 4,288.56

Lower Sling Tension (lbs): 3,714



Click Here To Order

Upper Slings

Leg Length (ft): 18

Leg Height (ft): 15.59

Sling Angle (°): 60

All Rigging Components

Item	Capacity (t)	Weight (lbs)	Qty	Total Weight (lbs)
Hoist Line	-	1,200	1	1,200
Block	-	250	1	250
Hook	20	750	1	750
Crosby Link A-342 4"	186.5	228	1	228
Crosby Shackle	-	-	2	-
Sling	-	-	2	-
Spreader	-	-	1	-
Sling	-	-	2	-
Total Rigging Weight:				2,428
Load	-	5,000	1	5,000
Net Load Weight:				7,428

Update Next

I have selected to add rigging to the upper part of my upper slings. You can select to add a shackle, pick between Crosby or Columbus McKinnon or customize your own. As you select the model and size of the shackle you will notice that 3D Lift Plan has added 2 shackles to the upper part of your slings.

You will notice as you add rigging that all the information is added to the above info box, and the weights of all the rigging is added to the load weight.

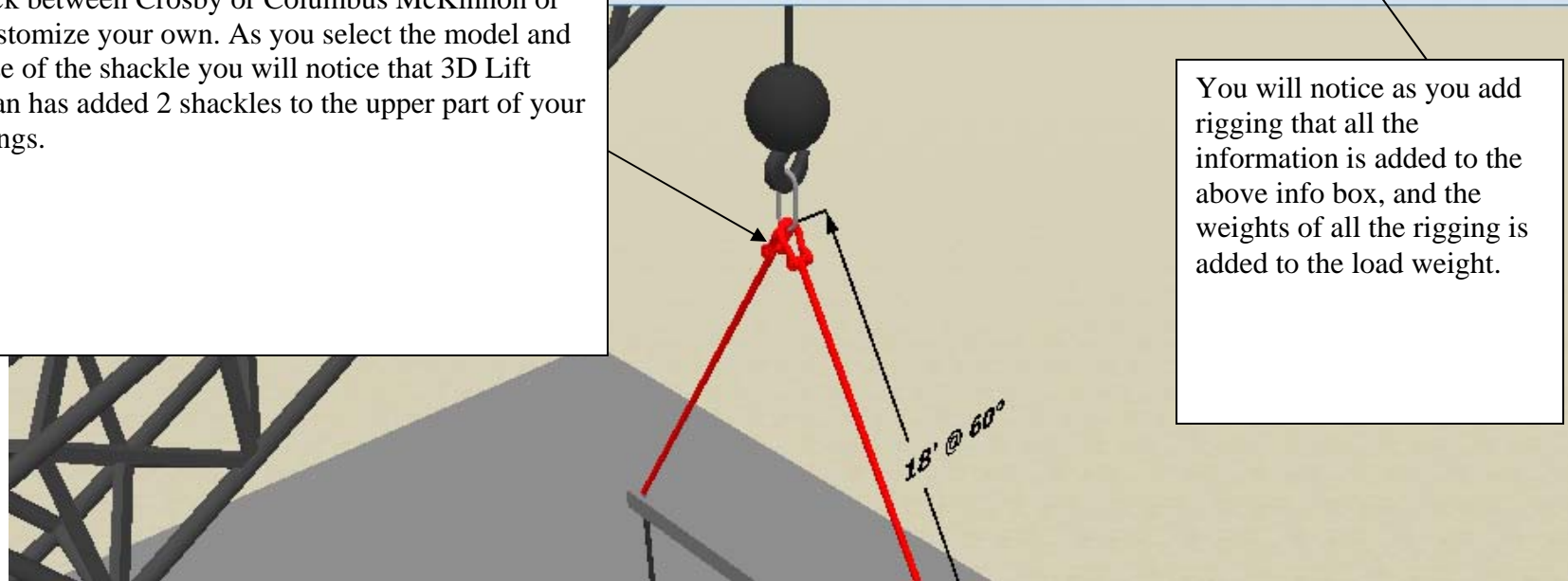

Advanced Rigging Cont'd

Select Rigging Leg

Upper Slings ▾



Rigging Components

X Shackle ▾  Name: Crosby 5

Crosby Shackle ▾ Size (ft): 0.88

G-209 ▾ Weight (lbs): 85.75

2-1/2" ▾ Capacity (t): 55

Flip Rotate

Add object... ▾

Add object... ▾

Sling Name: Sling

Length (ft): 18

Diameter (ft): 0.26

Weight (lbs): 700

Capacity (t): 10

Add object... ▾

Add object... ▾

Hook

Lifting Lug

Link

Shackle

Sling Tension

Supporting Legs: 2 ▾

Upper Sling Tension (lbs): 5,118.77

Lower Sling Tension (lbs): 4,499.75



Click Here To Order

Upper Slings

Leg Length (ft): 18.88

Leg Height (ft): 16.6

Sling Angle (°): 61.53

All Rigging Components

Item	Capacity (t)	Weight (lbs)	Qty	Total Weight (lbs)
Hoist Line	-	1,200	1	1,200
Block	-	250	1	250
Hook	20	750	1	750
Crosby Link A-342 4"	186.5	228	1	228
Crosby Shackle G-209 2-1/2"	55	85.75	2	171.5
Sling	10	700	2	1,400
Spreader	-	-	1	-
Sling	-	-	2	-
Total Rigging Weight:				3,999.5
Load	-	5,000	1	5,000
Net Load Weight:				8,999.5

Back
Update
Next

You will notice that you have 2 places you can select rigging, above and below. On the previous page rigging was added to the upper part of the sling and the rigging that was selected was above the Sling.

To add rigging to the lower part of the sling add rigging below the Sling section.

Adding Obstructions

3D Lift Plan Coordinate System

The 3D Lift Plan Coordinate System is oriented as shown in the image below. X and Z values represent a location on the ground. Y values represent a vertical distance above the ground. Grid lines are drawn every 10 ft or 10m if you are using metric units.

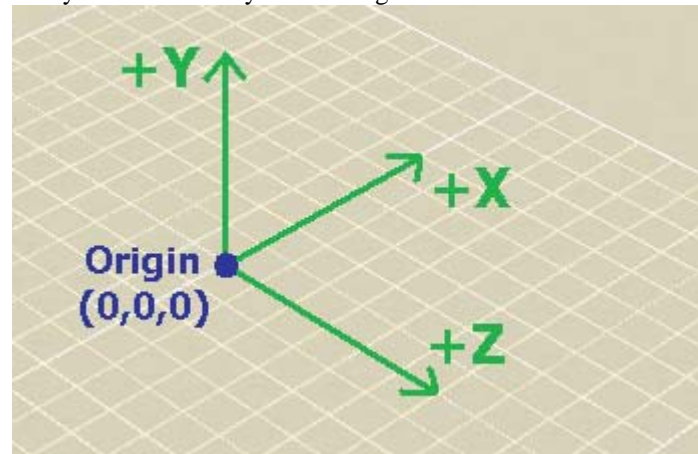

Adding an object to the Jobsite

You build and edit your jobsite from the Jobsite Obstructions page, which can be reached by clicking the "Obstructions" link on the left-side menu when you are creating a lift plan.

To add a new object to the jobsite, press the "Add New Object" button.

Jobsite Object			
Object to Edit:	<input type="text"/>		
Object Name:	<input type="text"/>		
Shape:	3D Object	<input type="text"/>	
Color:	Gray	<input type="text"/>	
<input type="button" value="Add New Object"/>		<input type="button" value="Delete This Object"/>	

A simple box will be created. If this is the first object you are adding to the jobsite, the front edge of the box will be placed at the jobsite origin.

In 3D Lift Plan, the Length of an object always corresponds to its size in the X-direction. The Width always corresponds to the Z-dimension.

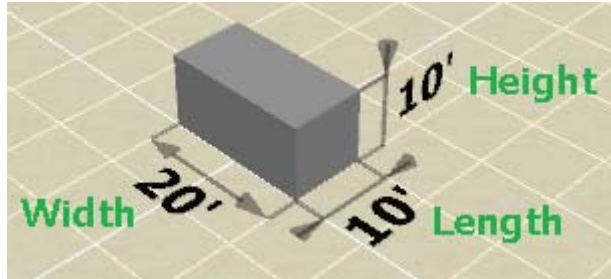

To change the dimensions of the object, edit the "Length", "Width", and "Height" values in the Object Properties box, then press the "Update" button.

To change the location of the object, edit the "Center X", "Center Z", and "Bottom" values. For instance, to position the default box so the front edge is 20 ft from the jobsite origin, set "Center X" to 25 ft, accounting for the 10 ft length of the object.

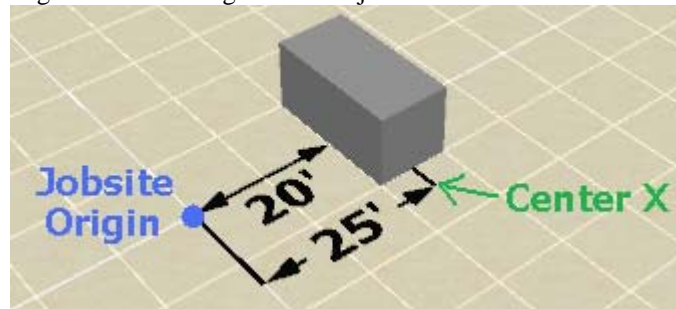







Note: When only one object exists on the jobsite, the program will keep its front edge at the jobsite origin by default. To move the object in the x-direction you will need to uncheck the "Keep object edge at origin" checkbox.

Selecting a 3D Object

You can change the shape of the object in the "Shape" dropdown list.

Jobsite Object			
Object to Edit:	Obj001	Center X (ft):	5
Object Name:	Obj001	Center Z (ft):	0
Shape:	Box	Bottom (ft):	0
Color:	Gray	Rotation (°):	0
		Length (ft):	10
		Width (ft):	20
		Height (ft):	10
<input type="button" value="Add New Object"/>		<input type="button" value="Delete This Object"/>	

You can choose from the pre-defined objects like Box, Cylinder, and Text, or you can select "3D Object" to display one of many detailed custom 3D objects that are included with 3D Lift Plan. After selecting "3D Object" from the list, you will be transferred to the 3D Object Selection page. Choose one of the Categories on the left, then select which object you want to use. Some objects are free to use, but some require purchase.

Category...			
My Purchased Objects			
Basic Shapes	Double Circuit Tower <input type="button" value="Select"/>	Transmission Tower <input type="button" value="Select"/>	Transmission Tower with Insulators <input type="button" value="Select"/>
Buildings			
Ground			
Miscellaneous			
People			
Pipes			
Power Lines			
Railroad			
Roads			
Structures			
Towers			
Trees and Shrubs			
Vehicles			
Vessels			
Walkways			
Wind Turbine			
Sub-categories...			

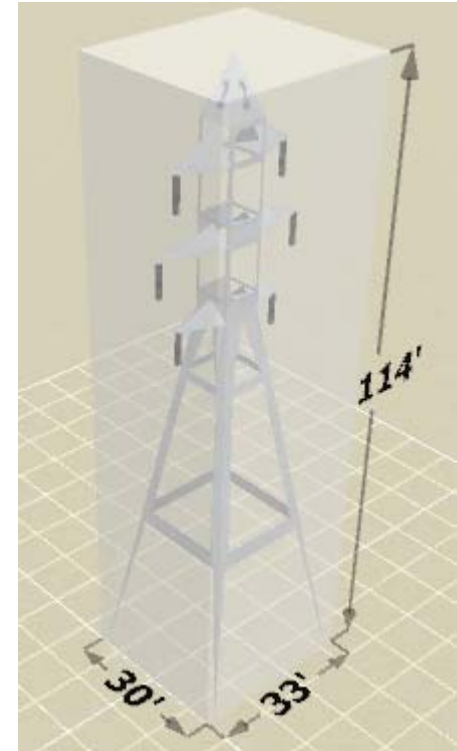

To place objects on the jobsite use the controls in the center column. Center X is the placement on the jobsite lengthwise. If you building is 10' long and you want your building to start at 0 then the number you put in Center X is 5. You will use positive and negative numbers to move the objects into place.

To place an object like a power line you will want to put the height in the Bottom cell. So if you want a power line to start at 100' in the air, put 100 in the Bottom cell.

Box Object

The screenshot displays the '3D LIFT PLAN' software interface. The top navigation bar includes 'Home', 'Features', 'News', 'Support', and 'My Account'. The user is logged in as 'Demo1' and can click 'Logout'. The left sidebar contains sections for 'Settings', 'Lift Setup', 'Crane Search', and 'Lift Plan'. The main area is titled 'Jobsite Obstructions' and contains a table for editing objects.

Jobsite Object		
Object to Edit: Obj001	Center X (ft): 5	Length (ft): 10
Object Name: Obj001	Center Z (ft): 0	Width (ft): 20
Shape: Box	Bottom (ft): 0	Height (ft): 10
Color: Gray		

Below the table are buttons for 'Add New Object', 'Delete This Object', 'Back', 'Update', 'Search Cranes', and 'Choose Crane'. A 3D view at the bottom shows a gray box object on a grid. A white dot marks the starting point at the origin (0,0,0). A coordinate system with X, Y, and Z axes is visible. The box dimensions are labeled as 10' length, 20' width, and 10' height. The starting point is at the center of the box's base.

Annotations in the image point to various controls:

- Choose Object to Edit:** Points to the 'Object to Edit' dropdown menu.
- Name Object:** Points to the 'Object Name' input field.
- Choose Object Shape and color:** Points to the 'Shape' and 'Color' dropdown menus.
- Add New Object:** Points to the 'Add New Object' button.
- Starting point at white dot:** Points to the white dot at the origin in the 3D view.
- Controls to place the object on the jobsite:** Points to the 'Center X (ft)', 'Center Z (ft)', and 'Bottom (ft)' input fields.
- Controls to change dimension of each object:** Points to the 'Length (ft)', 'Width (ft)', and 'Height (ft)' input fields.

Cylinder Object

Jobsite Obstructions

To add an obstruction, click the 'Add New Object' button, then choose it's shape and enter it's dimensions.

Enter the dimensions of the Cylinder, and location you want to place it on the jobsite.

Jobsite Object					
Object to Edit:	Obj001	Center X (ft):	7.5	Height (ft):	30
Object Name:	Obj001	Center Z (ft):	0	Diameter (ft):	15
Shape:	Cylinder	Bottom (ft):	0		
Color:	Gray				

To search for cranes that can perform this lift, click 'Search Cranes'. To choose a specific crane, click 'Choose Crane'.

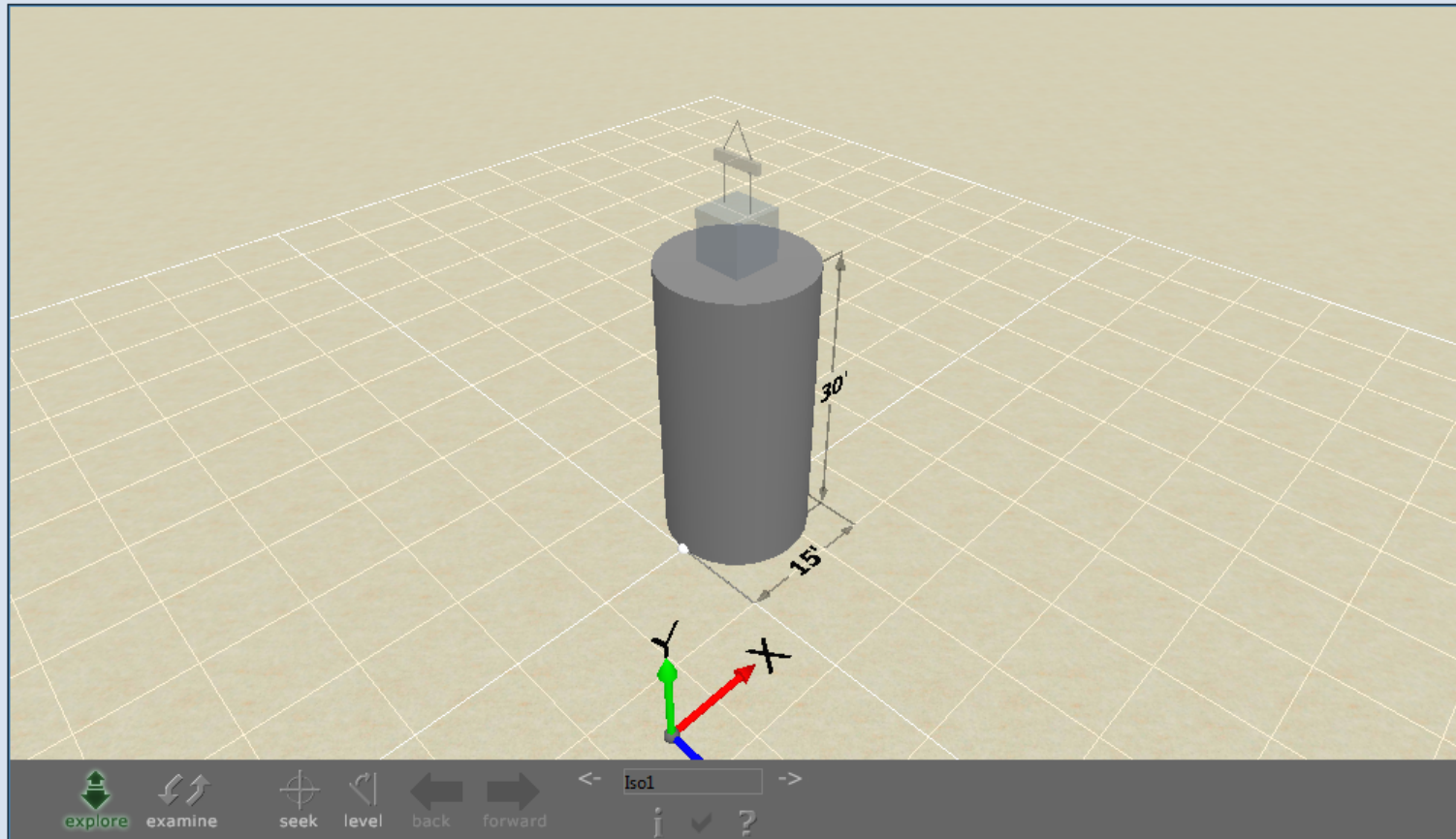

Sphere Object

Jobsite Obstructions

To add an obstruction, click the 'Add New Object' button, then choose it's shape and enter it's dimensions.

Enter the diameter of the sphere, and the location.

Jobsite Object			
Object to Edit:	Obj001	Center X (ft): 15	Diameter (ft): 30
Object Name:	Obj001	Center Z (ft): 0	
Shape:	Sphere	Bottom (ft): -15	
Color:	Gray		

To search for cranes that can perform this lift, click 'Search Cranes'. To choose a specific crane, click 'Choose Crane'.

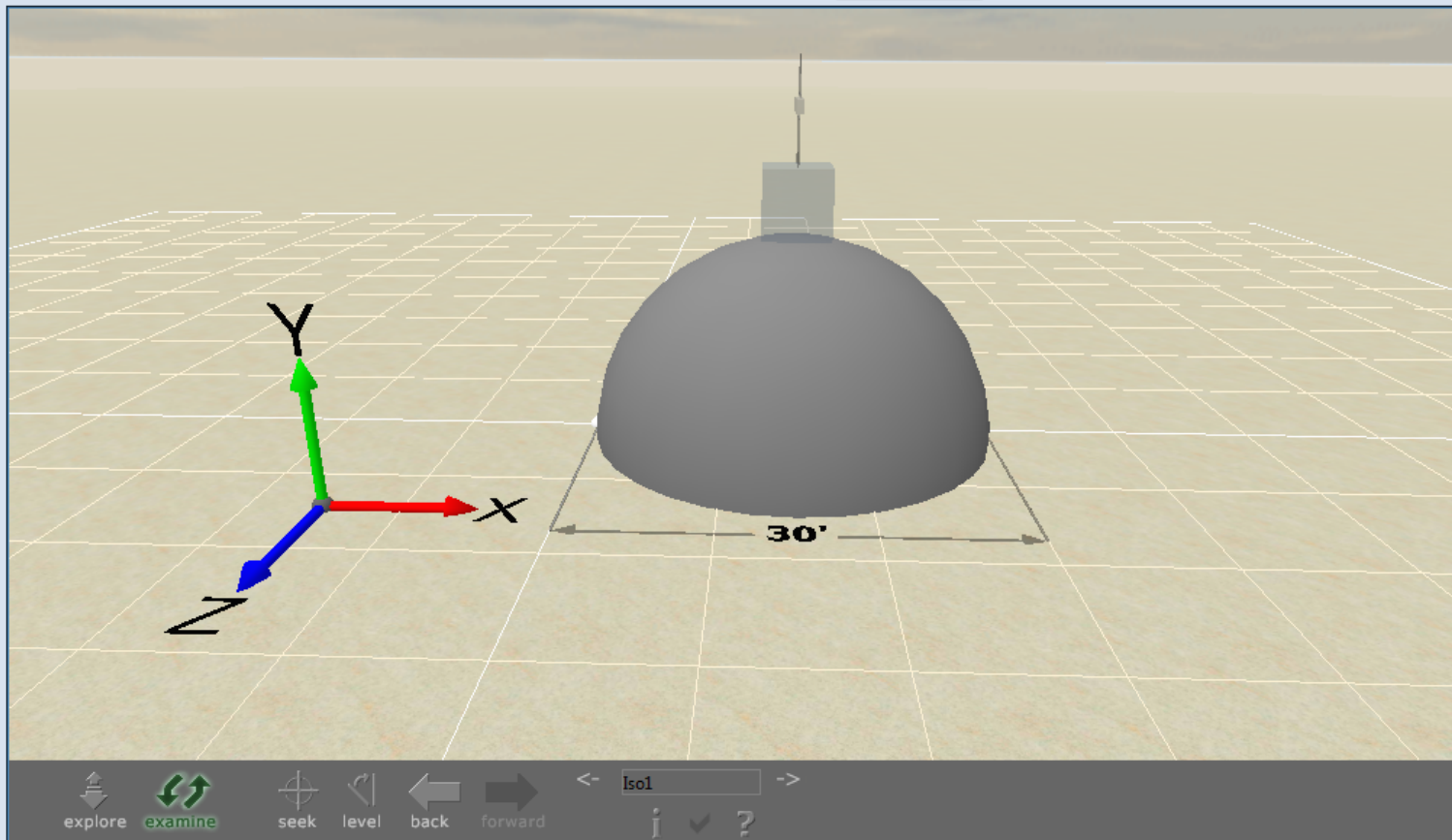

Construction Building Object

Jobsite Obstructions

To add an obstruction, click the 'Add New Object' button, then choose it's shape and enter it's dimensions.

Enter the dimensions of the building, how many floors the building has, and where you want it on the iobsite.

Jobsite Object					
Object to Edit:	Obj001	Center X (ft):	15	Length (ft):	30
Object Name:	Obj001	Center Z (ft):	0	Width (ft):	30
Shape:	ConstrBuilding	Bottom (ft):	0	Height (ft):	30
Color:	Gray	Rotation (°):	0	Floors:	5

To search for cranes that can perform this lift, click 'Search Cranes'. To choose a specific crane, click 'Choose Crane'.

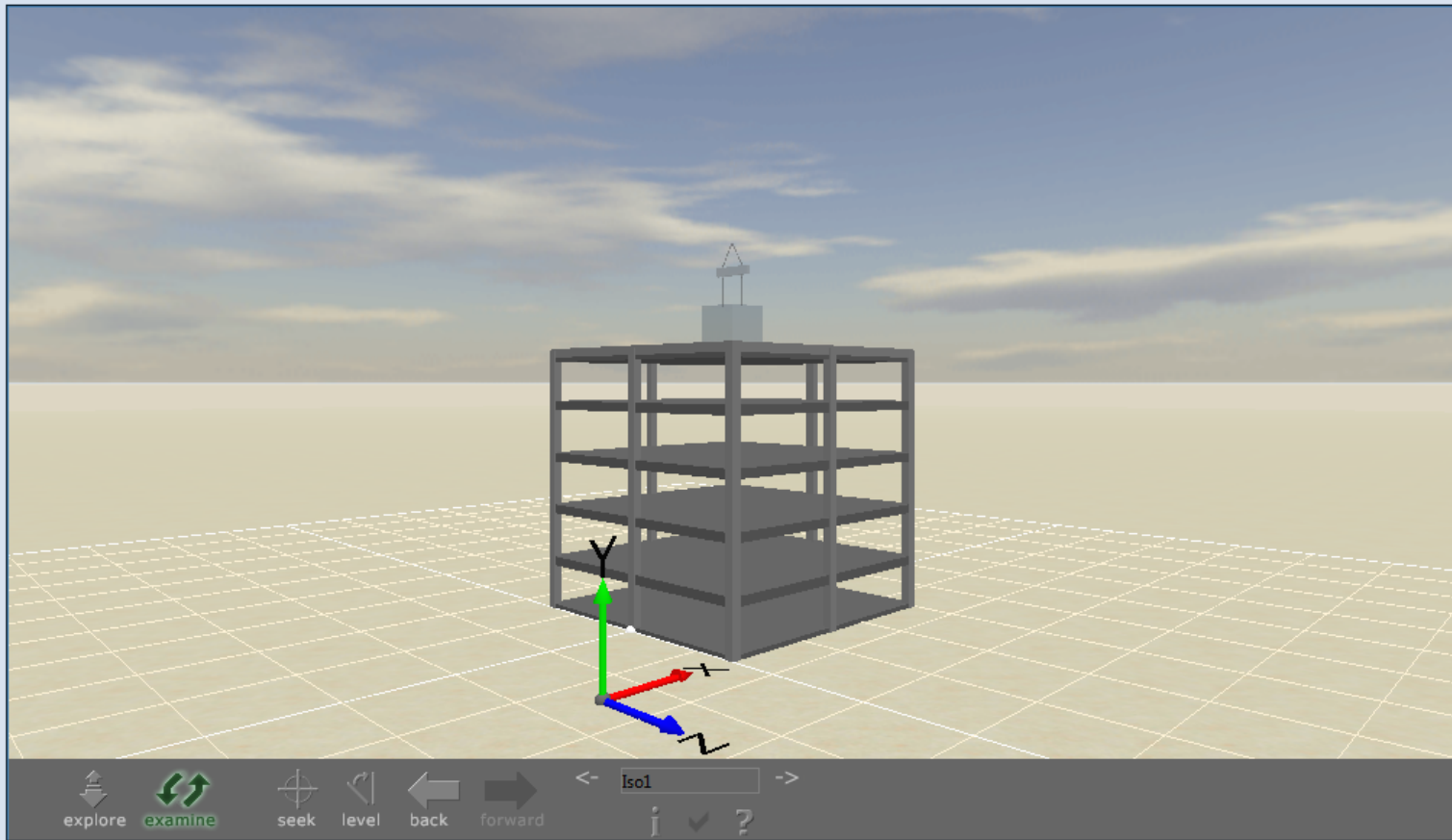

Rope Object

Jobsite Obstructions

To add an obstruction, click the 'Add New Object' button, then choose it's shape and enter it's dimensions.

X1 represents the starting point in the x direction of your rope; X2 represents the ending point of your rope in the x direction. Same applies with the Y1 and Y2, Z1 and Z2. The sag represents how far down you want the rope to sag in the middle.

Jobsite Object					
Object to Edit:	Obj001	X1 (ft):	0	X2 (ft):	30
Object Name:	Obj001	Y1 (ft):	10	Y2 (ft):	10
Shape:	Rope	Z1 (ft):	30	Z2 (ft):	30
Color:	Gray	Radius (ft):	0.5	Sag (ft):	2

To search for cranes that can perform this lift, click 'Search Cranes'. To choose a specific crane, click 'Choose Crane'.

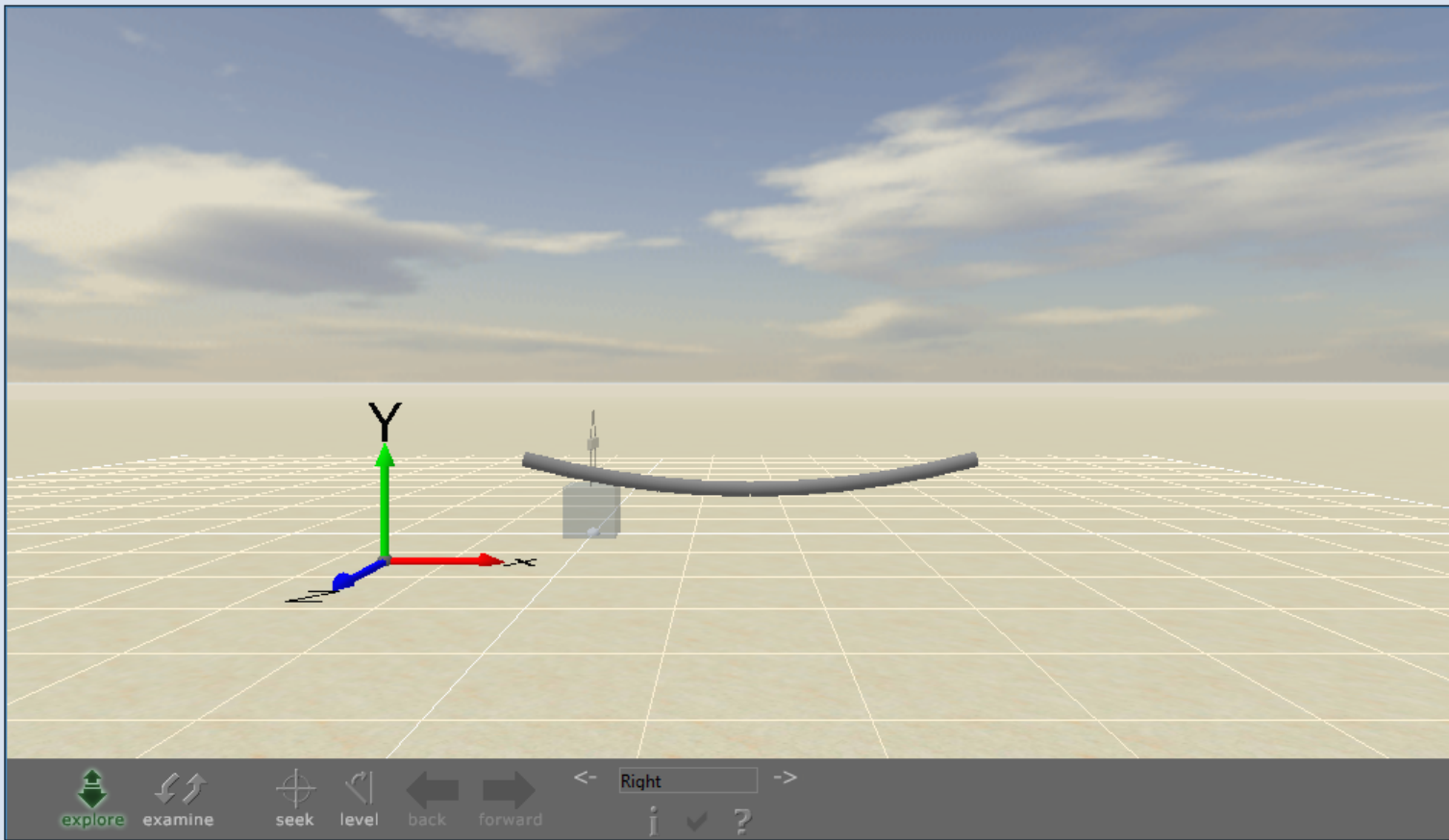

Adding Text to your Jobsite

Jobsite Obstructions

To add an obstruction, click the 'Add New Object' button, then choose its shape and enter its dimensions.

Enter the X, Y, Z coordinates for where you would like to place the text on the jobsite.

Select Text from the Shape dropdown box.

Jobsite Object			
Object to Edit:	Obj001	X (ft):	25
Object Name:	Obj001	Y (ft):	20
Shape:	Text	Z (ft):	0
Color:	3D Object		
	Box		
	Cylinder		
	Sphere		
	ConstrBuilding		
	Rope		
	Lattice Section		
	Text		

Buttons: Delete This Object, Update, Search Cranes, Choose Crane

Type in the text you would like to appear, Enter the Font Size.

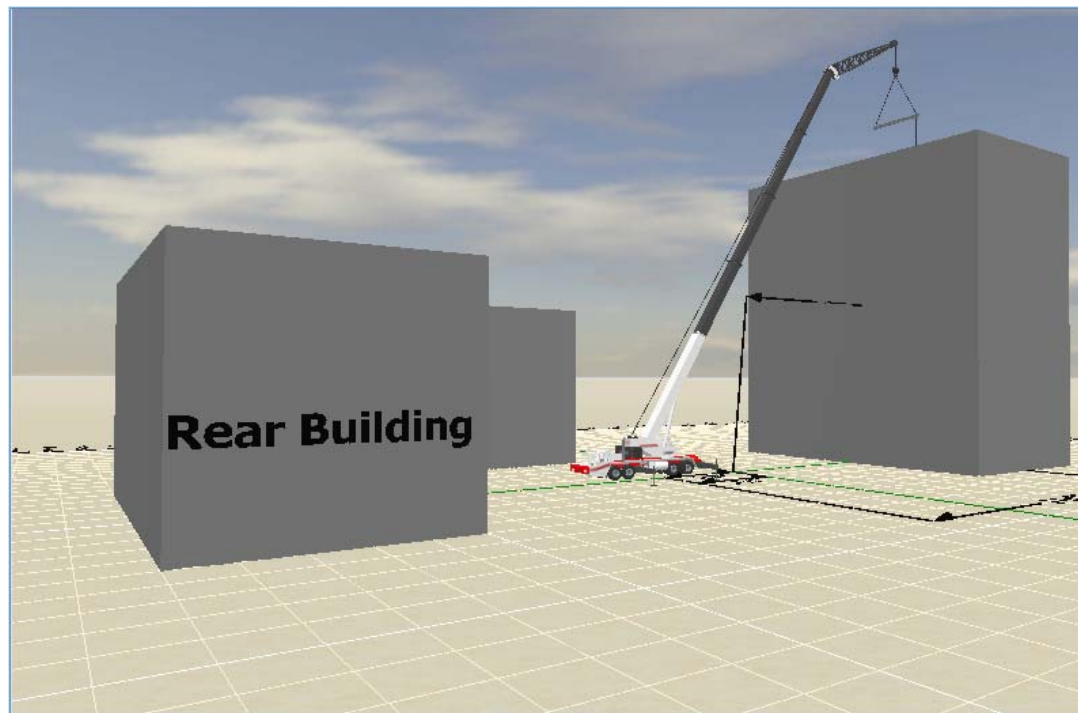

3D Objects Obstruction

Select the category of the object you want to add.











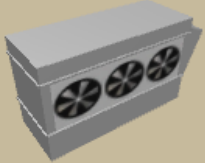

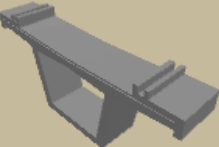

Some categories also have a sub category.

You will need credits in your account to purchase some of the objects. Some objects are free. To purchase credits you can return to the My Account Page and purchase credits.

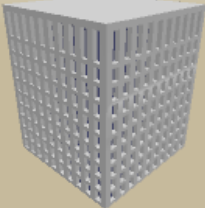
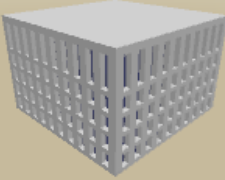
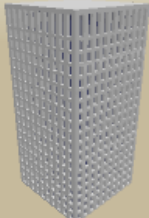
Category...

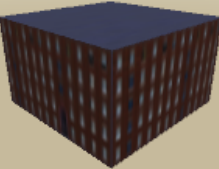
- My Purchased Objects
- Basic Shapes
- Buildings
- Ground
- Miscellaneous
- People
- Pipes
- Power Lines
- Roads
- Structures
- Towers
- Trees and Shrubs
- Vehicles
- Vessels
- Walkways
- Wind Turbine

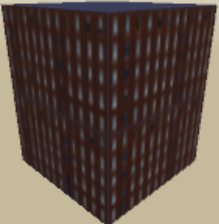
Sub-categories...

 AC Unit 01 <input type="button" value="Select"/>	 Asphalt <input type="button" value="Select"/>	 Bridge Section <input type="button" value="Select"/>	 Building 01 <input type="button" value="Select"/>
 Building 01 (Short) <input type="button" value="Select"/>	 Building 01 (Tall) <input type="button" value="Select"/>	 Building 02 <input type="button" value="Select"/>	 Building 02 (Tall) <input type="button" value="Select"/>
 Building 04 <input type="button" value="Select"/>	 Building 04 (Short) <input type="button" value="Select"/>	 Building 04 (Tall) <input type="button" value="Select"/>	 Building 05 <input type="button" value="Select"/>
 Building 06 <input type="button" value="Select"/>	 Building 06 (Short) <input type="button" value="Select"/>	 Building 06 (Tall) <input type="button" value="Select"/>	 Cargo_Ship2 <input type="button" value="Select"/>

Can't find what you want?

Email support@3dliftplan.com to request an object. We can create any custom object you need.

Credits

You have 960 credits.

Credits are required to purchase 3D Objects. You can get credits by clicking the "Purchase Credits" link on your account page.

You can purchase the use of all 3D Objects from your [Account Information](#) page.

Choose Crane Page

3D LIFT PLAN Home Features News Support My Account

Logged in as Demo1
Logout

Settings
Lift Plan Settings

Lift Setup
Load Type
Load Dimensions
Rigging Type
Rigging Details
Obstructions
Choose Crane

Crane Search
Search Setup
Search Cranes
Search Results

Lift Plan
Dimensions
Load Chart
Lift Simulation
Print

Choose Crane
Select the crane you want to use from the lists. Then specify the configuration of the crane. All the Load Charts that fit the configuration will be listed below. Click the 'Use This Chart' button next to the Load Chart you want to use.

You can also select the exact crane you would like to use for the job. Choose the manufacture, and model you would like to use. You can also select the exact configuration you want to use.

Crane Configuration

Crane Make:	All My Cranes....	Clear Selections	
Crane Model:	Link-Belt: 298 HSL - Horsehead Tip Extension		
Boom Length (ft):	130	Jib Length (ft):	3
Boom Angle (°):	Any	Upper Jib Length (ft):	Any
		Mast Length (ft):	Any

Back

Select one of the following Load Charts...

	Boom	Jib	Base	Counterweight	Range	Capacity%	Chart ID
Use This Chart	Main Boom	Horsehead Tip Extension	Crawlers	ABCDE+A	360°	75%	

Select any of the links above to make changes to your load, jobsite or choose cranes from your list of cranes or from the crane search results.

Find the list of configurations and select the one you would like to use.

Lift Simulation Page

Select any of the links above to make changes to your load, jobsite or choose cranes from your list of cranes or from the crane search results. You can also select to add Dimensions to your jobsite or view the load chart.

Click the button next to boom length for intermediate boom lengths. Click the button next to boom angle to lay the boom and jib down flat to determine the setup area needed

3D LIFT PLAN A1A Software GPS Tracking Services DIY Web Design Marketplace Logged in as tawnia (Admin) Logout

Home Features Crane List News Training Forums **NEW** Support My Account Admin

Settings Lift Plan Settings

Lift Simulation Link-Belt HTC-8690, Main Boom (Mode EM1), 35' Offset Fly, 100% Outriggers, CWT: 14500 lbs, 360°, 85% Capacity, D11P2127

Lift Setup Quick Lift Setup Load Type Load Details Rigging Type Rigging Details Advanced Rigging Obstructions Choose Crane Multi-Crane

Crane Search Search Setup Search Cranes Search Results

Lift Plan Load Chart Lift Simulation Dimensions Print Export Share

View: Iso1

Snapshots Snapshot 1 Save Snapshot

1" = 0.08 ft
2" = 0.17 ft
3" = 0.25 ft
4" = 0.33 ft
5" = 0.42 ft
6" = 0.50 ft
7" = 0.58 ft
8" = 0.67 ft
9" = 0.75 ft
10" = 0.83 ft
11" = 0.92 ft

Crane Configuration

Center Pin X (ft): -25	+	-	Boom Length (ft): 140	(%s)
Center Pin Z (ft): 0	+	-	Boom Angle (°): 58.38	
Crane Height (ft): 0	+	-	Jib Length (ft): 35	
Carrier Angle (°): 0	+	-	Jib Offset (°): 30	
Swing Angle (°): 0	+	-	Load Location (ft): X: 75 Y: 100 Z: 0	
Hook Height (ft): 135.09	+	-	Load Angle/Rotation: A: 0 R: 0	

Previous Page Update Print

Results

Lift Radius (ft): 100
Tip Height (ft): 146.38
Net Load Weight (lbs): 5,000
Chart Capacity (lbs): 6,700

Refer to in-cab chart before lifting.

Add Crane

Position your crane by entering your center pin location. You can also change the height of your crane to put it on top of a mat or up a hill.

Use these controls to change the location of the crane on the jobsite, change carrier, swing angle and hook height. Change the boom length, boom angle, jib length and offset or set your lift radius.

Change the Load Location, or change the angle or rotation of the load

To print your lift plan left click on the Print button

Monitor the radius, tip height and chart capacity as you simulate the lift.

Add additional cranes to the website by clicking on Add Crane link.

explore examine seek level back forward Iso1 ?

If you don't see a 3D image, click here to install the Flux Player

Dimensions Page

The screenshot shows the 'Dimensions Page' interface with several sections and callout boxes:

- Crane Section:** A table with columns for dimension name and Y-value. The 'Lift Arc' row has a checked checkbox and 'Y: 0'. Other rows include 'Tailswing Arc', 'Tip Arc', 'Origin (XZ)', and 'Origin (Y)'. A callout box points to the 'Lift Arc' checkbox with the text: "Select which dimensions you want to show on your lift plan."
- Load Section:** A table with checkboxes for 'Length', 'Width', and 'Height'. A callout box points to the 'Length' checkbox with the text: "Use the dropdown box to select the Obstruction you want to turn dimensions on for. Place a check in box next to the dimension you want to show for the Load and Obstructions."
- Obstructions Section:** A dropdown menu showing 'Obj001' and checkboxes for 'Length', 'Width', and 'Height'. A callout box points to the 'Obj001' dropdown with the text: "Use the dropdown box to select the Obstruction you want to turn dimensions on for. Place a check in box next to the dimension you want to show for the Load and Obstructions."
- Custom Dimensions Section:** A form with fields for 'Description', 'Style' (set to 'XYZ-Distance'), 'Point #1', 'Point #2', 'Offset', and 'Y-Offset'. A 'Delete' button is next to the 'Description' field. A callout box points to the 'Style' dropdown with the text: "If you want to place an arc in the air to show where tower cranes may intersect, simply enter the height you want the arc to be."
- Links Section:** A list of links: 'Add New Dimension', 'Add Setup Distance', 'Add Lift Radius', 'Add Tip Height', 'Add Hook Height', 'Add Load Height', 'Add Load Distance', and 'Add Tailswing'. A callout box points to the 'Add New Dimension' link with the text: "Click the Add New Dimension link to use our custom dimension feature."
- Buttons:** 'Previous Page' and 'Update' buttons are at the bottom.
- Final Callout:** A callout box points to the 'Add Load Height' link with the text: "Click one of these links to turn on any of these dimensions."

Custom Dimension Feature

With the custom dimension feature you can draw a dimension from any 2 points on the jobsite. You can use the coordinate system to select 2 points on the grid. Or you can select any point or edge on the crane, load or any obstruction. Use the dropdown list to determine the starting and ending point.

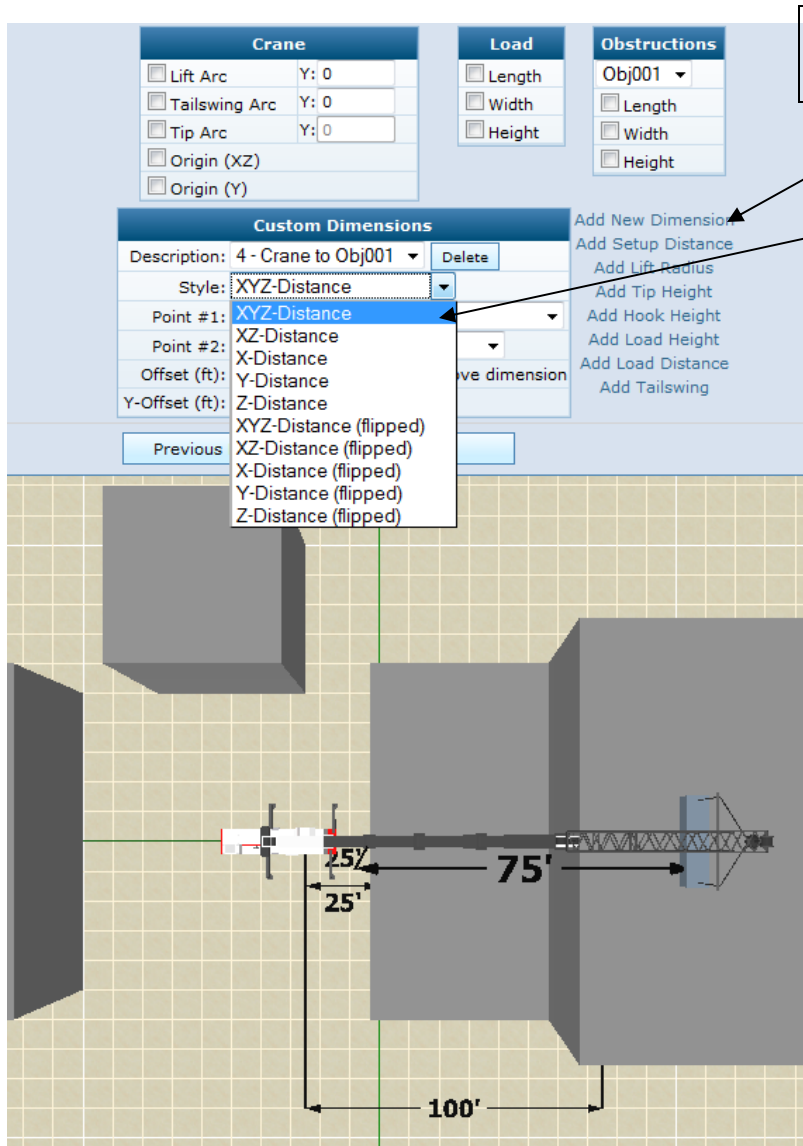

Click the link Add New Dimension

Select the direction your dimension will run.

XYZ Distance- Diagonal dimension that measures distances between 2 points that 1 point is higher than the other and at an angle, not straight up and down.

XZ Distance- Diagonal dimension that is at the same height but is at an angle

X Distance- A dimension that runs straight in the X direction
Z Distance- A dimension that runs straight in the Z direction

Flipped distances flip the text in the opposite direction

Custom Dimension Feature Cont'd

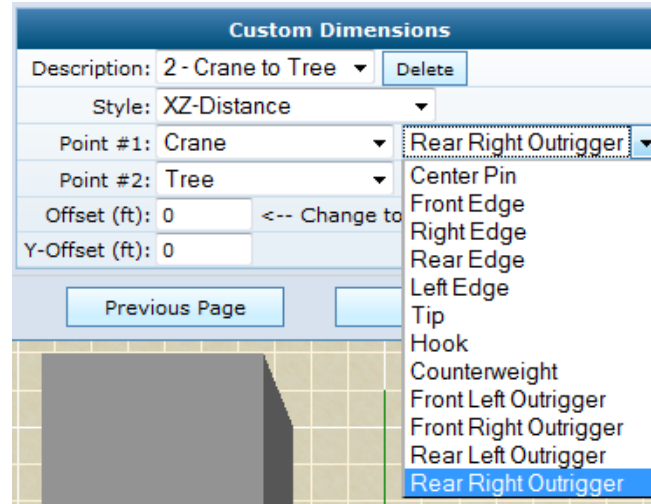
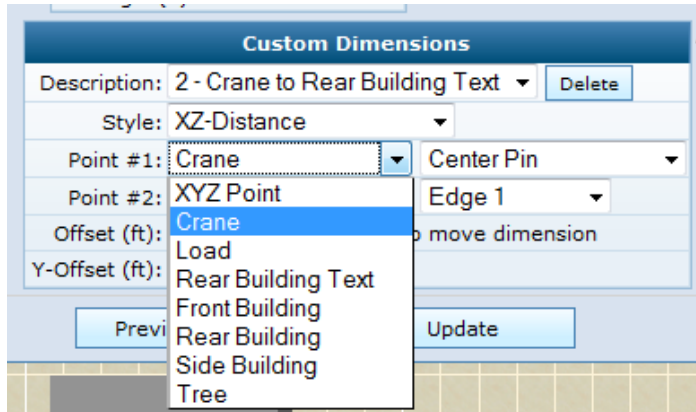

If we want to measure the distance between the right front outrigger and the tree I will first select an XZ distance because the dimension will run in both the X and Z direction. Next select your starting point for the dimension.

Point #1- Select the crane from the dropdown list then select the Rear Right Outrigger. This will be the starting point for the dimension.

Point #2- Select Tree then Center. This will draw a diagonal dimension between the Front Outrigger and the Center of the Tree.

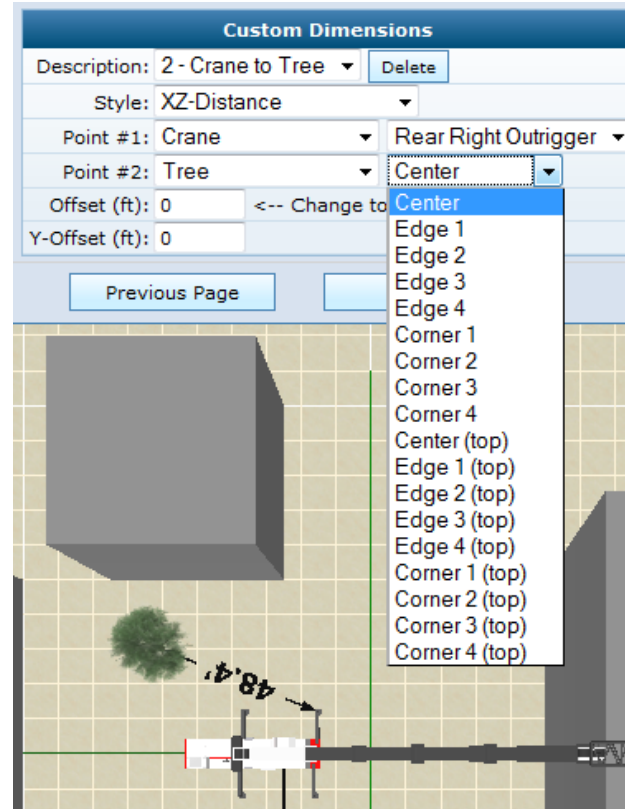
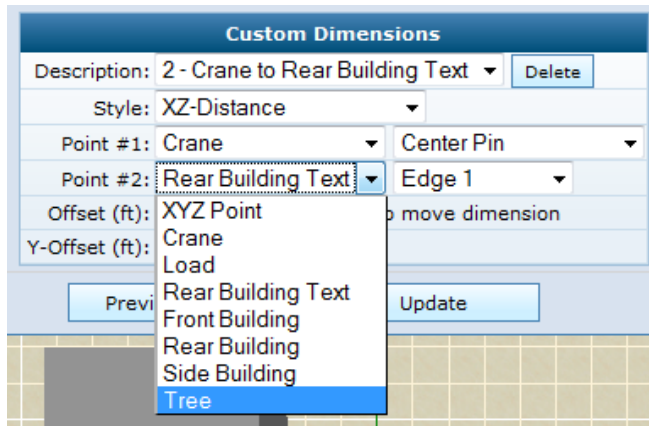

Load Chart Page

Liebherr LR 1280				Deductions			
Boom: Main Boom (Main Boom Head 2220-1)				Stowed Jib Deduction (lbs): 0			
Jib: -				Capacity Deduction (lbs): 0			
Base: On 2-Extended Track Width Crawlers		Counterweight: 188,500 lbs + 79,400 lbs Carbody		Capacity Deduction (lbs): 0			
Range: 360°		Capacity: 75%		Chart ID: 9833243-39805			

This data is for reference use only. Operator must refer to in-cab charts to determine allowable lifting capacities.

Boom Length (ft)	Jib Length (ft)	Jib Offset	Load Radius (ft)	Tip Height (ft)	Boom Angle	Capacity (lbs)	Note
142	-	-	19	149	86°	416,400	
142	-	-	20	149	85.8°	416,400	
142	-	-	25	149	83.7°	379,900	
142	-	-	30	148	81.7°	292,500	
142	-	-	35	147	79.7°	252,300	
142	-	-	40	146	77.6°	206,600	
142	-	-	45	144	75.5°	174,200	
142	-	-	50	143	73.4°	150,100	
142	-	-	55	141	71.3°	131,000	
142	-	-	60	139	69.1°	116,600	
142	-	-	65	137	66.9°	104,500	
142	-	-	70	134	64.7°	94,400	
142	-	-	75	132	62.4°	85,900	
142	-	-	80	129	60.1°	78,600	

View the Load Chart for the configuration you are using.

You can enter in for a stowed jib deduction, wind, etc.

Printing

The screenshot shows the '3D LIFT PLAN' website with a navigation menu (Home, Features, News, Marketplace, Services, Support, My Account) and a sidebar with categories like Settings, Lift Setup, Crane Search, and Lift Plan. The main content area is titled 'Print Lift Plan' and contains a 'Launch 3D Lift Plan Publisher' link and a 'Lift Plan Worksheet' link. A 'Previous Page' button is visible below the worksheet link. A grey box at the bottom of the page asks 'Would you like to create a PDF document of your Lift Plan?' and provides instructions for using CutePDF Writer.

3D LIFT PLAN Admin

Home Features News Marketplace Services Support My Account

Settings
Lift Plan Settings

Lift Setup
Quick Lift Setup
Load Type
Load Details
Rigging Type
Rigging Details
Obstructions
Choose Crane

Crane Search
Search Setup
Search Cranes
Search Results

Lift Plan
Load Chart
Lift Simulation
Dimensions
Print
Export

Iso1

Print Lift Plan

Click the link below to start 3D Lift Plan Publisher, which allows you to customize and create printouts.

[Launch 3D Lift Plan Publisher](#)

Please note, Internet Explorer is required to use the printing feature of 3D Lift Plan.
If you are having trouble launching 3D Lift Plan Publisher: [Install the desktop version](#)

Click on this link to launch the 3D Lift Plan Publisher to print out your plan.

[Lift Plan Worksheet](#)

You will be transferred to a printer-friendly page where you can use your web browser's Print function to print the worksheet.
You can edit the text in every field of the worksheet.
When you are done, use your browser's Back button to return to this page.

Previous Page

Would you like to create a PDF document of your Lift Plan?

You can use "CutePDF Writer", a free program that enables you to create PDF documents.

Step 1) Click this link....Install [CutePDF Writer](#), then choose "Run" and install the application.
Step 2) Launch the 3D Lift Plan Publisher and press the "Print" button. The Print window will appear.
Step 3) Select "CutePDF Writer" as your printer, then press the "Print" button.
Step 4) After positioning the 3D image on the printout, you will be prompted for a location to save the PDF document. Take note of the location of the saved file so you can find the PDF document later.

If this is the first time you have tried to print, you might have to install the .net framework. You will see a grey box in this area that will tell you. Installing the .net framework takes some time to install. Most computers already have this installed from the manufacture.

3D Lift Plan Publisher

Select the layout format and resolution you want for your lift plan. You can select up to 4 images on the plan.

Enter a title, description and customer name for your lift plan.

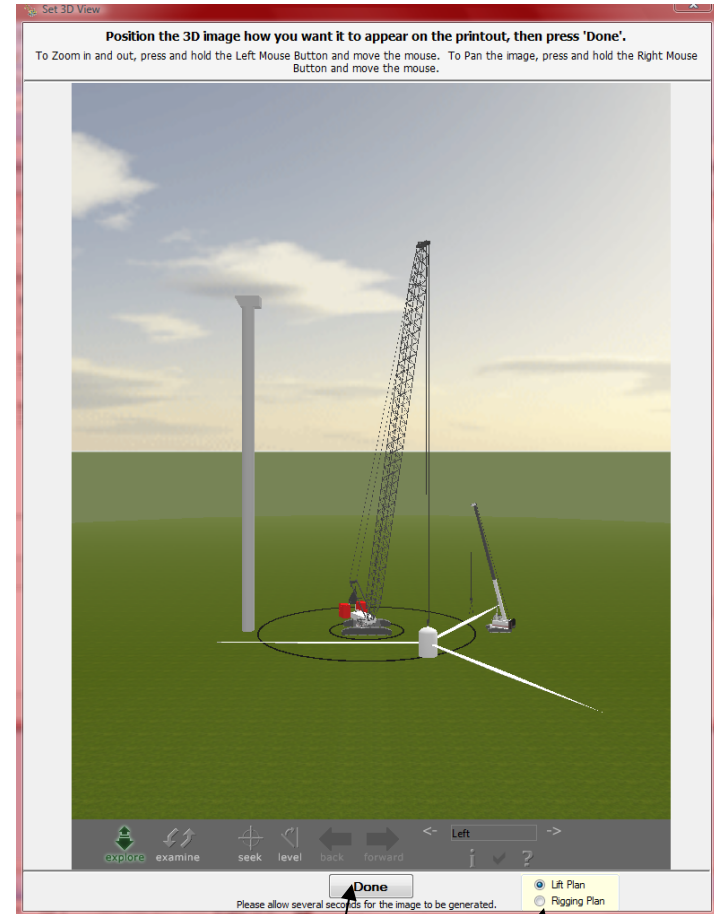
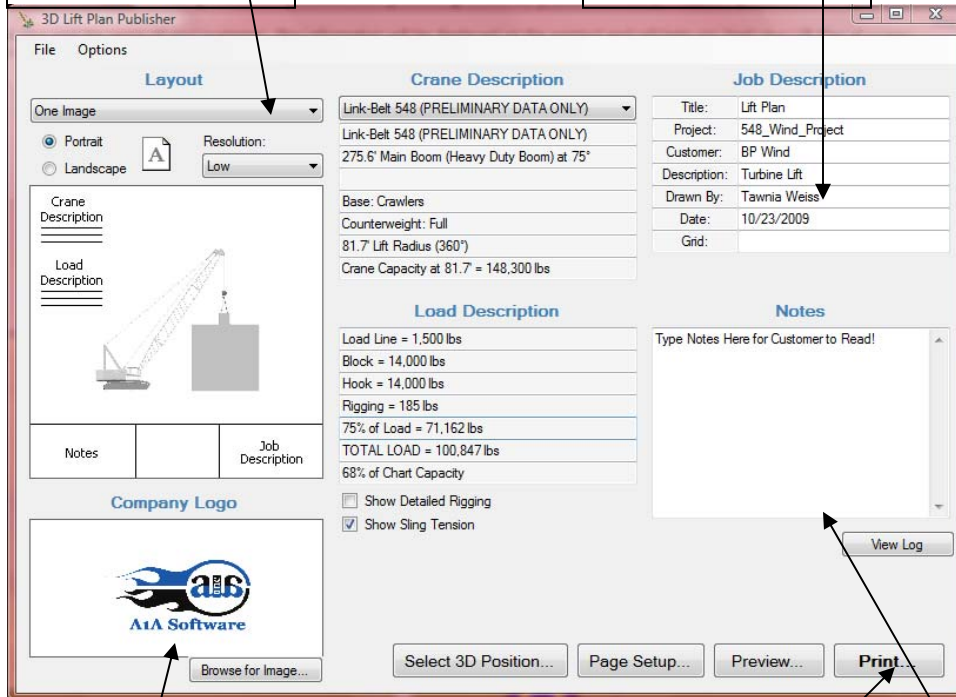

Add your company logo by clicking on the "Browse for Image" button and point to the file you want to use.

Click the Select 3D Position button to select the angle you want to print at.

Select the Print or Preview button to print out your plan.

Add general notes to your lift plan; enter ground bearing pressure info, or anything you want to show on your plan.

Select the 3D view you want to use in your lift plan using the flux controls located on the grey bar at the bottom of the image.

Select whether you want to print a rigging plan or a lift plan.

Printing Lift Plans to Paper or for Emailing to a Customer

To print your lift plans on paper simply select the printer you want to use.

To email lift plans to your customers you will need a program like Adobe Acrobat Professional, PDF Printfactory, Snagit, etc. Simply select the program from your list of printers (like Adobe PDF below) and name and save the pdf.

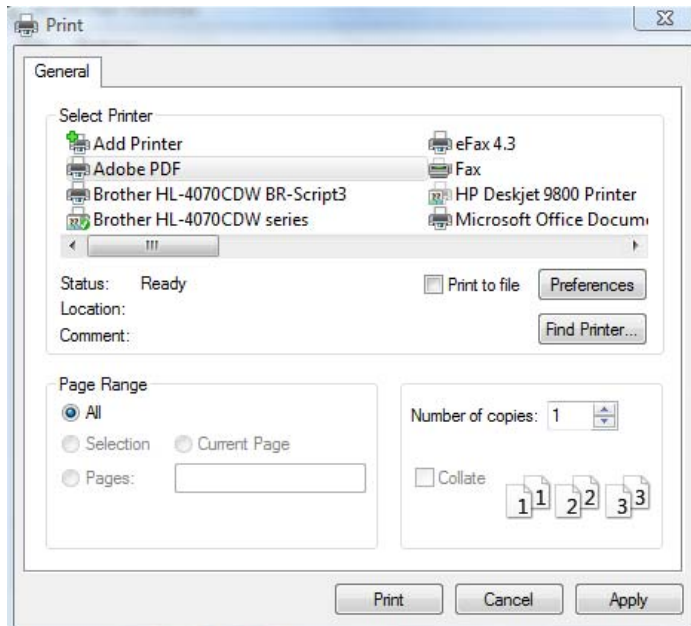

CRANE
 Link-Belt HTC-8675 Series II
 80' Main Boom (EM1) at 61.8°
 Base: Fully Extended Outriggers
 Counterweight: 0 lbs
 34.5' Lift Radius (360°)
 Crane Capacity at 34.5' = 27,400 lbs

LOAD
 Load = 1,000 lbs
 4% of Chart Capacity

Grid: 10' x 10'

Type general notes here, or ground bearing pressure		Title: A/C Unit2 Project: 12349 Customer: ABC Crane Description: Lifting Air Conditioning Unit Drawn By: Tawnia Weiss 8/6/2008
---	--	--

Created with 3D Lift Plan www.3dliftplan.com

Critical Lift Plan Worksheet

Lift Plan Worksheet	
Title: Revision 1 Date: 3/27/2009	
Project: Shands Hospital Job Number: 1234	
Description: Lifting Beam	
Jobsite Address: 1234 5th Ave	
Customer: ABC Company P.O./ Contract#: AB1234	
Lift Plan Drawing and Load Placement Drawing attached? <input type="checkbox"/> Yes <input type="checkbox"/> No	
Notes: _____	
Crane Information	Lift Information
Manufacturer: Kobelco	Crane Radius: 48.6 ft
Model: CK1000-III - Luffing	Crane Capacity at Radius: 32,600 lbs
Serial #: _____	Capacity at Pick Point: _____
Crane Rating: 100 t	Capacity at Set Point: _____
Crane Inspection Date: 12/12/2008	Notes: _____
Notes: _____	
Crane Configuration	Load Configuration
Crane Carrier: On Extended Crawlers	Description: Beam
Counterweight: 3 Cwt's + 2 Low Weights	Dimensions: 20 ft x 2.5 ft, 2.5 ft tall
Chart Capacity: 32,600 lbs	Load Weight: 5,000 lbs
Main Boom Length: 55' Main Boom	Rigging Weight: 1200 lbs
Boom Sections: _____	Hook Weight: 250 lbs
Parts of Line: 2	Block Weight: 200 lbs
Line Size: _____	Load Line Weight: 700 lbs
Capacity of Line @ Parts: _____	Total Weight: 5,000 lbs
Radius: 48.6 ft	Hook Height: 90.83 ft
Boom Angle: 88°	Sling Length: 20
Tip Height: 91.83 ft	Sling Angle: 63.25632°
Jib Used? <input type="checkbox"/> Yes <input type="checkbox"/> No	Sling Equipment #: 5410
Jib: 50' Luffing Jib	Sling Type: Nylon
Jib Offset: 48.66°	Sling Capacity: _____
Jib Angle from Ground: 39.34°	Spreader Bar #: _____
Ground Bearing Pressure (Worst Case): _____	Spreader Bar Capacity: _____
	Hook Block: _____
	Shackle Type: _____
	Shackle Qty: _____
	Shackle Capacity: _____
	Additional Rigging: _____
	Additional Rigging Capacity: _____
	% of Chart Capacity: 15%
	Chart Capacity Deduction: _____
	Deduct Capacity: _____
	Notes: _____
Setup Information	
Crane Setup: <input type="checkbox"/> Over Rear <input type="checkbox"/> 360° <input type="checkbox"/> Over Front <input type="checkbox"/> Over Side	
Setup Distance: _____	
Mat Used? <input type="checkbox"/> Yes <input type="checkbox"/> No	
Mat Dimensions: _____	
Ground Bearing Pressure below Mat: _____	
Notes: _____	

Title: _____ Date: 3/27/2009	
Project: basic Job Number: _____	
Notes: _____	Notes: _____
Notes: _____	Notes: _____
Notes: _____	Notes: _____
Notes: _____	Notes: _____
Pre-Lift Checklist	
Crane Operator: _____	Name: _____
Signalperson Assigned: _____	Name: _____
Communication Method: _____	
Crane Inspected by Operator? _____	Yes No
Rigging Inspected? _____	Yes No
All Permits Obtained? _____	Yes No
Are weather conditions OK? _____	Yes No
Wind OK? _____	Yes No
Are there Power Lines? _____	Yes No
Is Operators Certification Card current? _____	Yes No
Is area OK for entry and exit of jobsite? _____	Yes No
Has a pre-lift meeting between operator, signalperson, supervisor, and any and all other persons occurred? _____	Yes No
Other Considerations: _____	

Signatures	
Engineer: Name: _____	Signature: _____ Date: _____
Supervisor: Name: _____	Signature: _____ Date: _____
Operator: Name: _____	Signature: _____ Date: _____
Client: Name: _____	Signature: _____ Date: _____

Tower Crane Planning

Tower Configuration

Select a pre-defined tower configuration or build a custom tower by selecting the quantities of each tower section you want to use.

Add Crane 1) Terex-Peiner SK 355-25 Remove Crane

Choose the tower crane you want through the choose crane page. Then configure your tower crane using our Edit Tower feature.

Tower Configuration			
Tower Configuration:	212.92 ft		
Tower Sections	Quantity	Section Height	Total Height
Slewing Section:			
CLD33:	0	10.2 ft	0 ft
D33:	0	18 ft	0 ft
S60/S35 Transition:			
S60:	0	19.4 ft	0 ft
S35:	11	19.4 ft	213.6 ft
Tower Base:	Concrete Pad		
Total Tower Height:			222.75 ft

Previous Page

Next

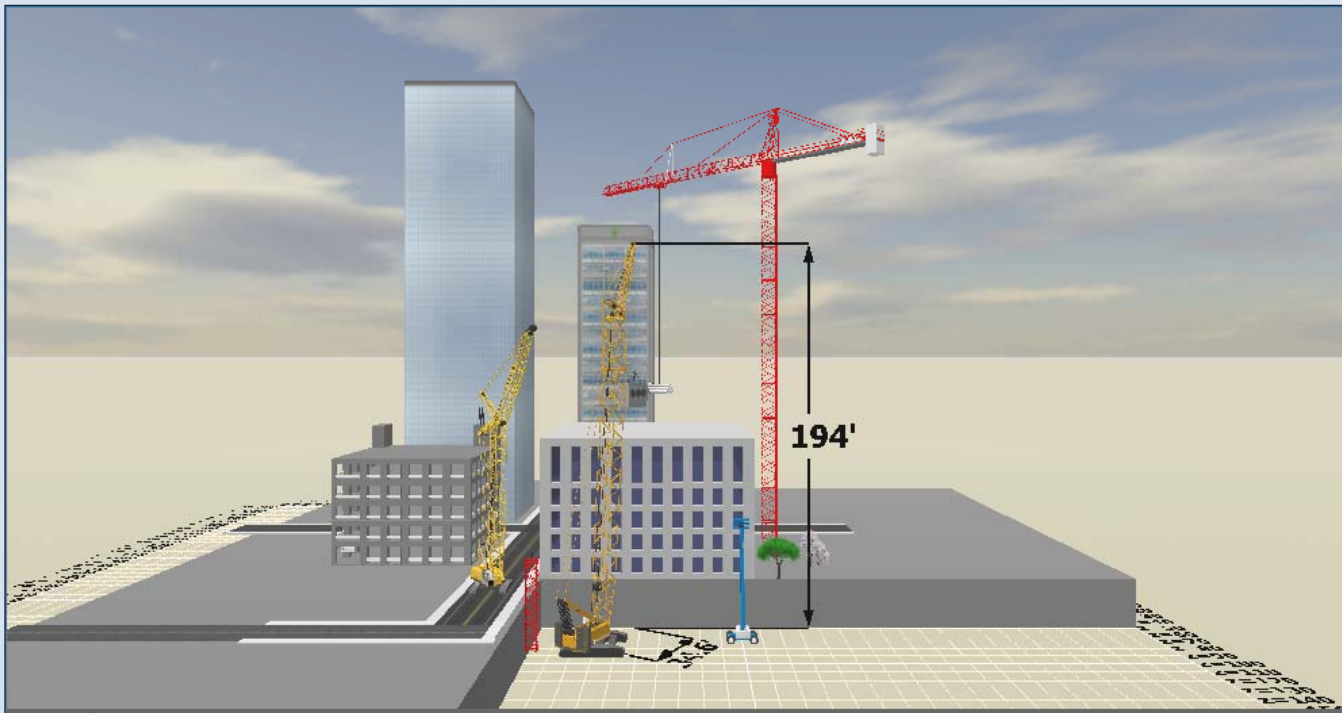

Ground Bearing Pressure

Lift Simulation

Kobelco CK1000-III, Main Boom, On Extended Crawlers, CWT: 3 Cwt's + 2 Low Weights, 360°, 75% Capacity

Crane Configuration				Results	
Center Pin X (ft):	-44.5	-	+	Boom Length (ft):	170
Center Pin Z (ft):	0	-	+	Boom Angle (°):	52.19
Crane Height (ft):	0	-	+	Jib Length (ft):	0
Carrier Angle (°):	0	-	+	Jib Offset (°):	0
Swing Angle (°):	0	-	+	Load Location (ft):	X: 65 Z: 0
Hook Height (ft):	101.86	-	+	Lift Radius (ft):	109.5

Lift Radius (ft):	109.5
Tip Height (ft):	139.52
Net Load Weight (lbs):	5,000
Chart Capacity (lbs):	9,470
Refer to in-cab chart before lifting.	

[Ground Bearing Pressure](#)

Previous Page Update Print

We are working on adding as many cranes we can find information on for ground bearing pressure. If we don't have your crane please let us know. **

If we have ground bearing pressure information you will notice on the lift simulation page under results a link for Ground Bearing Pressure. Click on that link to access the ground bearing pressure.

Ground Bearing Pressure

Kobelco CK1000-III, 170' Main Boom, On Extended Crawlers, CWT: 3 Cwt's + 2 Low Weights, 360°, 75% Capacity

[Add Crane](#)

	Lift Radius	Load Weight	Swing Angle
Crane:	109.5 ft	5,000 lbs	0°
GBP Chart:	110 ft	5,680 lbs	0°

Swing Angle	Left Crawler Toe Load	Left Crawler Heel Load	Bearing Length of Track	Right Crawler Toe Load	Right Crawler Heel Load
0°	23.4	0.4	17.8 ft	23.4	0.4
32°	26.4	2.7	17.8 ft	16.9	1.7
90°	16.9	16.9	17.8 ft	7	7

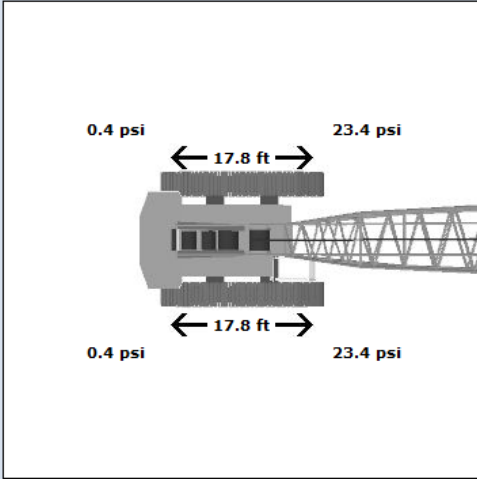

You will notice the information for the configuration and load you have selected.

Crane Setup

Lift Simulation

Kobelco CK1000-III, Main Boom, Luffing Jib, On Extended Crawlers, CWT: 3 Cwt's + 2 Low Weights, 360°, 75% Capacity

Crane Configuration				Results	
Center Pin X (ft):	-14.5	-	+	Boom Length (ft):	55
Center Pin Z (ft):	0	-	+	Boom Angle (°):	88
Crane Height (ft):	0	-	+	Jib Length (ft):	50
Carrier Angle (°):	90	-	+	Luffing Offset (°):	48.66
Swing Angle (°):	0	-	+	Load Location (ft):	X: -14.5 Z: 109.78
Hook Height (ft):	90.83	-	+	Lift Radius (ft):	109.8

Lift Radius (ft):	109.8
Tip Height (ft):	2.08
Net Load Weight (lbs):	5,000
Chart Capacity (lbs):	0
Refer to in-cab chart before lifting.	

No lines of the load chart match the current configuration.

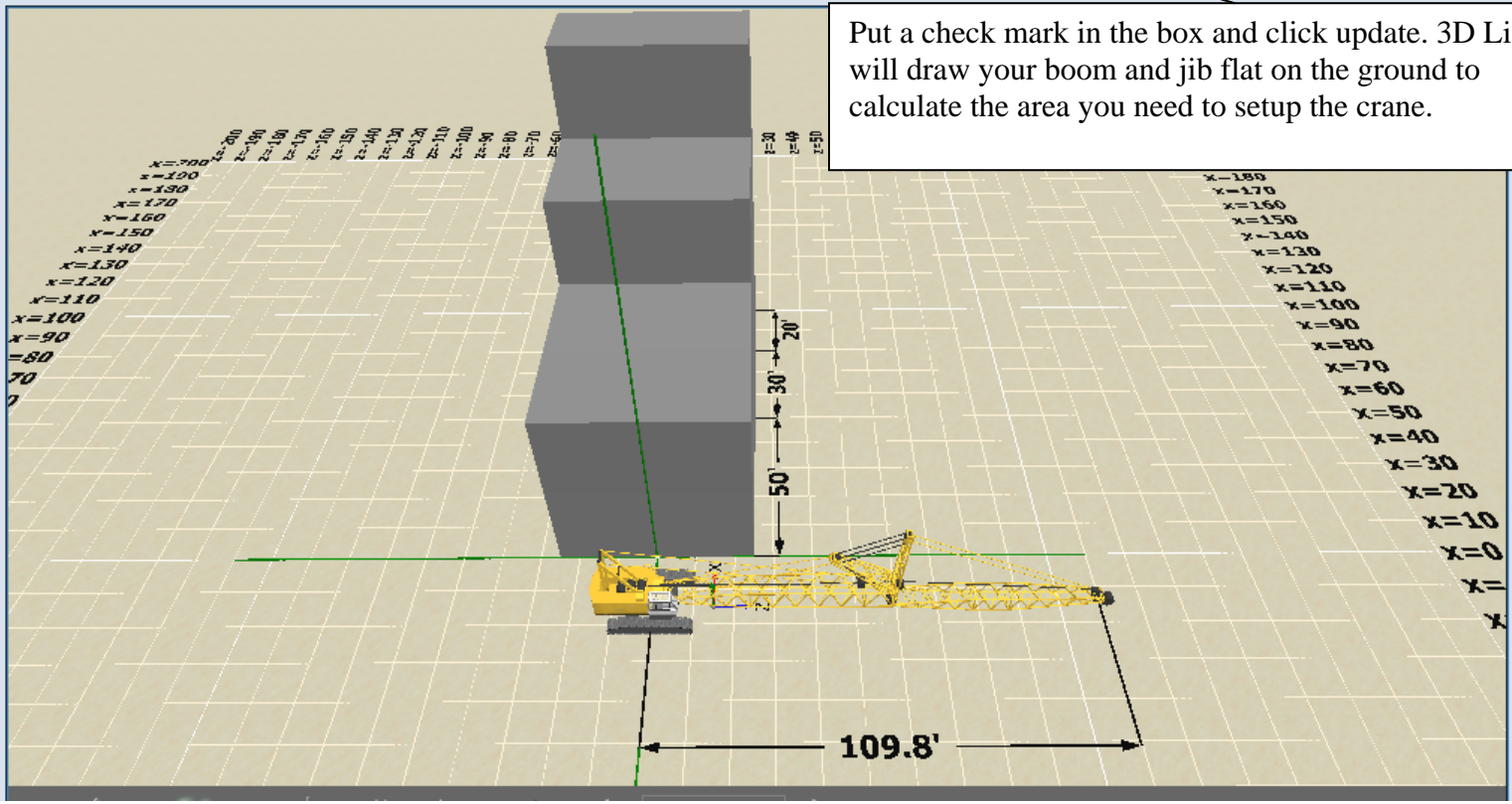

Put a check mark in the box and click update. 3D Lift Plan will draw your boom and jib flat on the ground to calculate the area you need to setup the crane.

CAD Export

3D LIFT PLAN

Admin

Logged in as tawnia (Admin)
Logout

Home
Features
News
Marketplace
Services
Support
My Account

Settings

Lift Plan Settings

Lift Setup

Quick Lift Setup
Load Type
Load Details
Rigging Type
Rigging Details
Obstructions
Choose Crane

Crane Search

Search Setup
Search Cranes
Search Results

Lift Plan

Load Chart
Lift Simulation
Dimensions
Print
Export

Lift Simulation

Kobelco CK1000-III, Main Boom, Luffing Jib, On Extended Crawlers, CWT: 3 Cwt's + 2 Low Weights, 360°, 75% Capacity

Crane Configuration	
Center Pin X (ft):	-14.5
Center Pin Z (ft):	0
Crane Height (ft):	0
Carrier Angle (°):	90
Swing Angle (°):	270
Hook Height (ft):	90.83
Boom Length (ft):	55
Boom Angle (°):	88
Jib Length (ft):	50
Luffing Offset (°):	48.66
Load Location (ft):	X: 34.06 Z: 0
Lift Radius (ft):	48.6

Results	
Lift Radius (ft):	48.6
Tip Height (ft):	91.83
Net Load Weight (lbs):	5,000
Chart Capacity (lbs):	32,600
Refer to in-cab chart before lifting.	

Previous Page
Update
Print

Iso1

explore
examine
seek
level
back
forward
Iso1

Click on the Export Link to export your lift plan to load into AutoCAD.

CAD Export Cont'd

3D LIFT PLAN Admin Logged in as tawnia (Admin)
Logout

Home Features News Marketplace Services Support My Account

Settings Export Lift Plan Add Crane
Lift Plan Settings

Lift Setup
Quick Lift Setup
Load Type
Load Details
Rigging Type
Rigging Details
Obstructions
Choose Crane

Crane Search
Search Setup
Search Cranes
Search Results

Lift Plan
Load Chart
Lift Simulation
Dimensions
Print

You can download the 3D drawing of your current Lift Plan in VRML 2.0 format (*.wrl), which can be loaded into most CAD programs.

[Download Lift Plan](#)

Previous Page

If your CAD program does not import WRL files, you can purchase [AccuTrans 3D](#) to convert the file to DXF, 3DS, OBJ, or other 3D formats. AccuTrans offers a 30-day free trial period and costs \$20 for long-term use. You can install AccuTrans 3D from their website by [clicking here](#).

Click the link to Download Lift Plan. You will be asked how and where you want to save the file.

Depending on the program you are loading the program into you may need to use a program like AccuTrans 3D to convert the exported file into the format your CAD program needs.

Multi-Crane Lift

Configure the Cranes

Set up the primary crane just like you would for any other lift. First, create the load and set up the rigging. Then build the jobsite, choose the crane configuration, and position the crane where you want it on the jobsite from the Lift Simulation page. You should also set the load angle and rotation so the load is in the correct position for the beginning of the lift.

Next, click the "Add Crane" button in the top-right corner of the screen. Select and configure the secondary crane and choose the load chart you want to use. From the Lift Simulation page, position the crane where you want it on the jobsite. If you would like to modify the rigging configuration for the secondary crane, click the "Rigging Type" link from the menu on the left. Don't worry about connecting the secondary crane to the load yet. That will be done in the next step.

At this point your lift plan should show the primary crane holding the load in it's initial position, and a secondary crane sitting nearby. My sample lift plan looks like this...

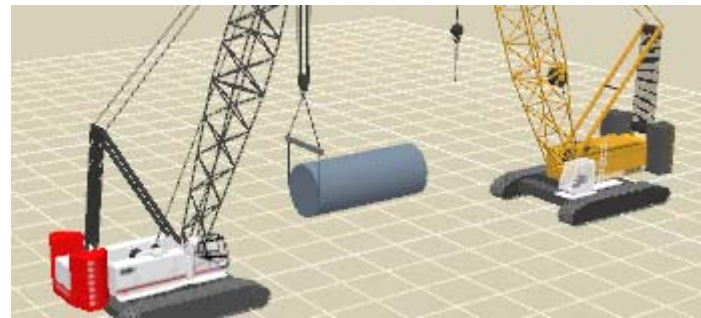

Set up the Multi-Crane Lift

Click the "Multi-Crane" link from the menu on the left. Choose your primary crane from the "Primary Crane" dropdown list:

Primary Crane:		Pick Points (ft)			
		X	Y	Z	Set pick point:
<div style="border: 2px solid red; padding: 2px;"> None None 1) Link-Belt 298 HSL 2) Liebherr LR 1280 </div>		0	0	0	Set to...
		<input checked="" type="checkbox"/> Load Rotates with Boom			
Secondary Cranes		Pick Points (ft)			
Lift Mode		X	Y	Z	Set pick point:
1) Link-Belt 298 HSL	None	0	0	0	Set to...
2) Liebherr LR 1280	None	0	0	0	Set to...

If you haven't done so already, position the pick points of the primary crane using the "Set pick point" list box or by manually setting the X, Y, and Z points. Now set the Lift Mode of the secondary crane by selecting one from the "Lift Mode" list box. Then position the pick points of the secondary crane using the "Set pick point" list box or by manually setting the X, Y, and Z points.

Lift Modes

Tandem - Boom

The secondary crane will hoist up or down to keep the load at its current angle. If the primary crane travels or booms up or down, the secondary crane will boom up or down to follow the load. The secondary crane carrier will not move.

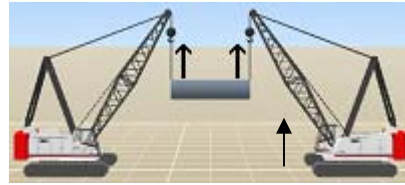

Tandem - Travel

The secondary crane will hoist up or down to keep the load at its current angle. If the primary crane travels or booms up or down, the secondary crane will travel to follow the load.

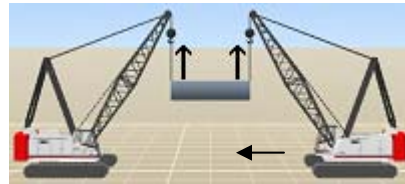

Trail - Boom

The secondary crane will keep its hook at the same height, tilting the load. If the primary crane travels or booms up or down, the secondary crane will boom up or down to follow the load. The secondary crane carrier will not move.

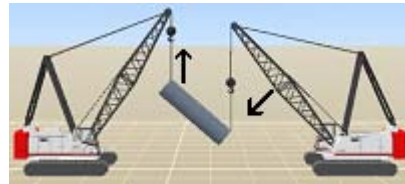

Trail - Travel

The secondary crane will keep its hook at the same height, tilting the load. If the primary crane travels or booms up or down, the secondary crane will travel to follow the load.

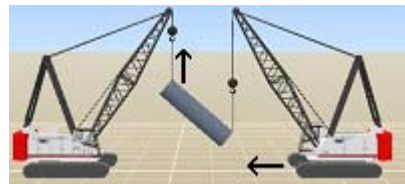

Simulate the lift

When you are done setting the Lift Mode and pick points for all cranes, click the "Lift Simulation" link from the menu on the left. Before simulating the lift, make sure the primary crane is selected in the multi-crane selection box at the top-right of the screen.

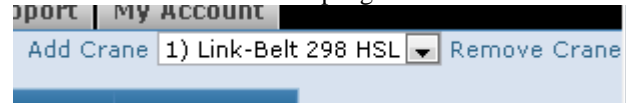

Now when you move the primary crane, the secondary crane will automatically adjust to follow the load. 3D Lift Plan will calculate the load on each crane throughout the lift and display it on the Lift Simulation page. You can position your mouse cursor over the Capacity field to see the current lift radius for any crane involved in the lift.

Results		
Lift Radius (ft):	28.4	
Tip Height (ft):	73.85	
Crane	Load (lbs)	Capacity (lbs)
1) Link-Belt 298 HSL	6,744	238,000
2) Liebherr LR 1280	5,006	30,200

Refer to in-cab chart before lifting. 47.8' radius

To reposition the secondary crane, select the crane in the multi-crane selection box at the top-right of the screen, then modify the Center Pin coordinates. Because the secondary crane is set up to automatically adjust to the primary crane, you will not be able to modify some values for the secondary crane.

Setting up the load and pick points tends to be the trickiest part of multi-crane lifts, so I thought some examples would be helpful...

Box Load

The first sample is a long box object. This example will apply to box, lattice, and custom 3D load objects. Our primary crane's pick points are 10' from the center of the load, so we set Rigging Offset to 10' on the Rigging Details page...

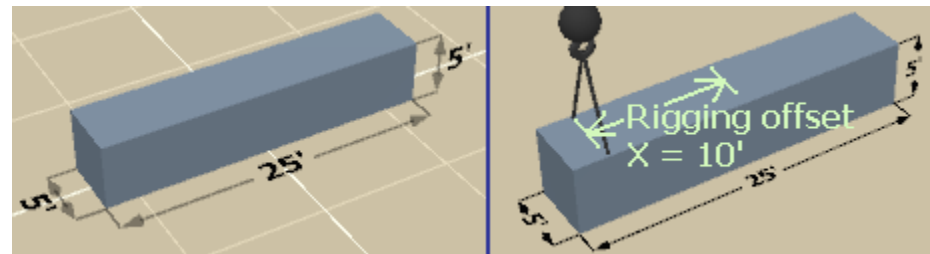

After adding the second crane, we position it in front of the primary crane by setting Center Pin X to 50' on the Lift Simulation page. To lift over the rear end of the crane, set the Carrier Angle to 180 degrees. Then, on the Multi-Crane page, we select the primary crane and set the secondary crane lift mode as described above. Then set the secondary crane Pick Point X to 10' and your lift will look like this...

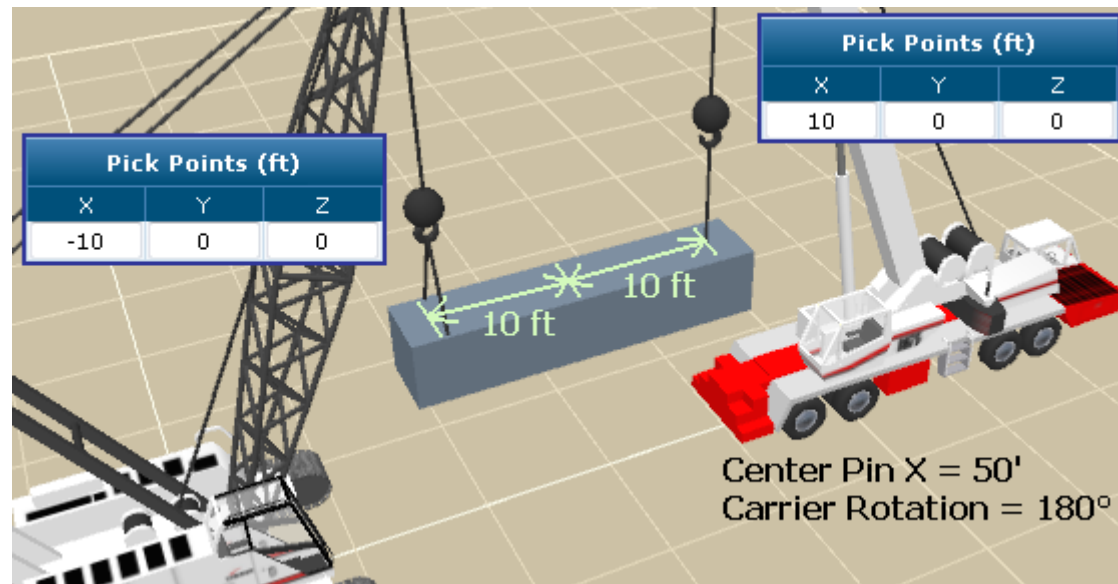

Box Load positioned sideways

In 3D Lift Plan, all multi-crane lifts need to occur along the length of the load. In order to set up a lift where the cranes are set up next to each other, you will need to rotate the 90 degrees on the Load Details or Lift Simulation page.

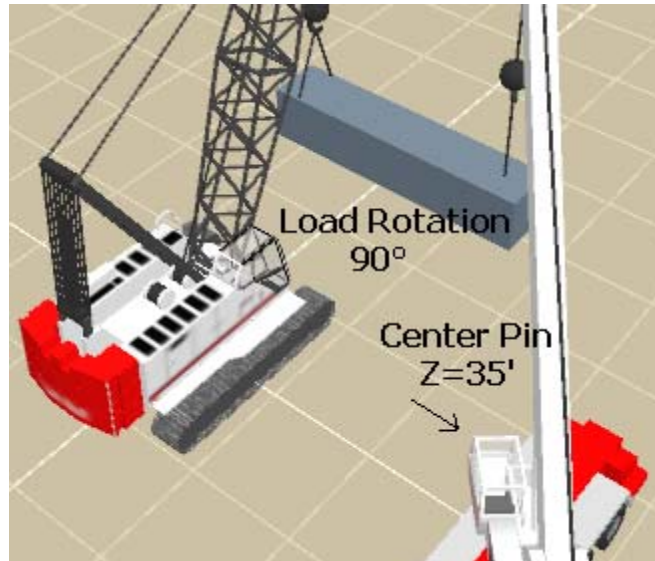

Cylindrical Load

When lifting a cylindrical load, you will often need to set the Load Angle to 90 degrees to lay it sideways. This rotates the load's coordinate system so the X dimension moves pick points up and down, and the Y dimension moves the pick points towards and away from the crane. Some examples are shown here...

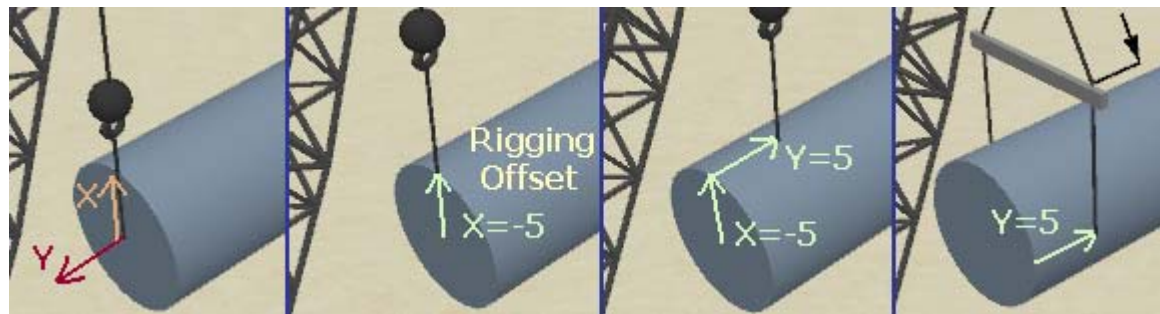

When setting up the secondary crane, you will typically need to set the Pick Point Y value to a negative number to move the pick points down towards the bottom end of the load...

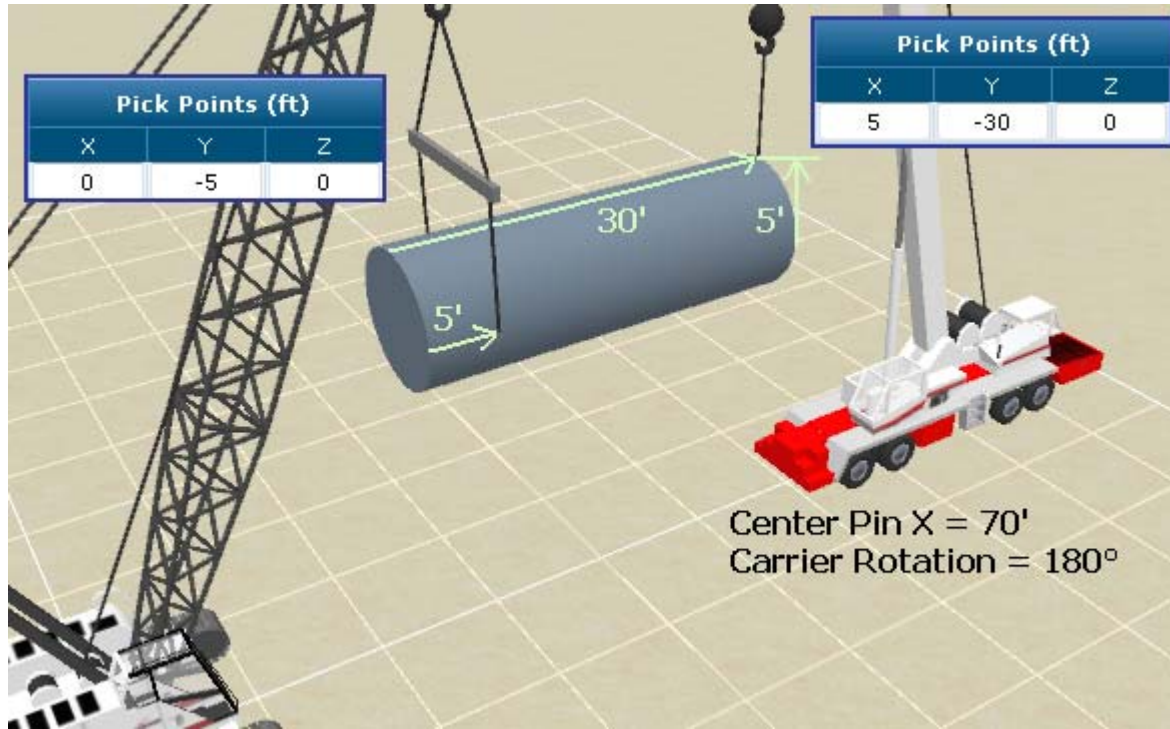

Share Feature

Send customers an electronic 3D version of the lift plan so they can look at the lift plan at any angle using the flux player controls.

Share Lift Plan

You can share your lift plan with anyone by sending them the link below. They will be able to see a 3D Image of your Lift Plan, crane and load information, and any notes you provide.

Anyone can view this Lift Plan by visiting the following web page:

www.3dliftplan.com/Viewer.aspx?id=CMCFL

The following notes will be displayed to anyone who views your Lift Plan:

Type Notes here for customer to read.

To view a preview of this page, click here: [View Preview](#)
Use your browser's Back button to return to this page.

To save changes, press 'Update'.

Previous Page

Update

Share Feature Cont'd

Job Information

Company: A1A Software

Job Description:

Crane: Link-Belt HTC-8690
140' Main Boom (Mode EM1)
35' Offset Fly
Counterweight: 14500 lbs
6,700 lbs capacity at 100'

Load: 5,000 lbs
75% of chart capacity

Type Notes here for customer to read.

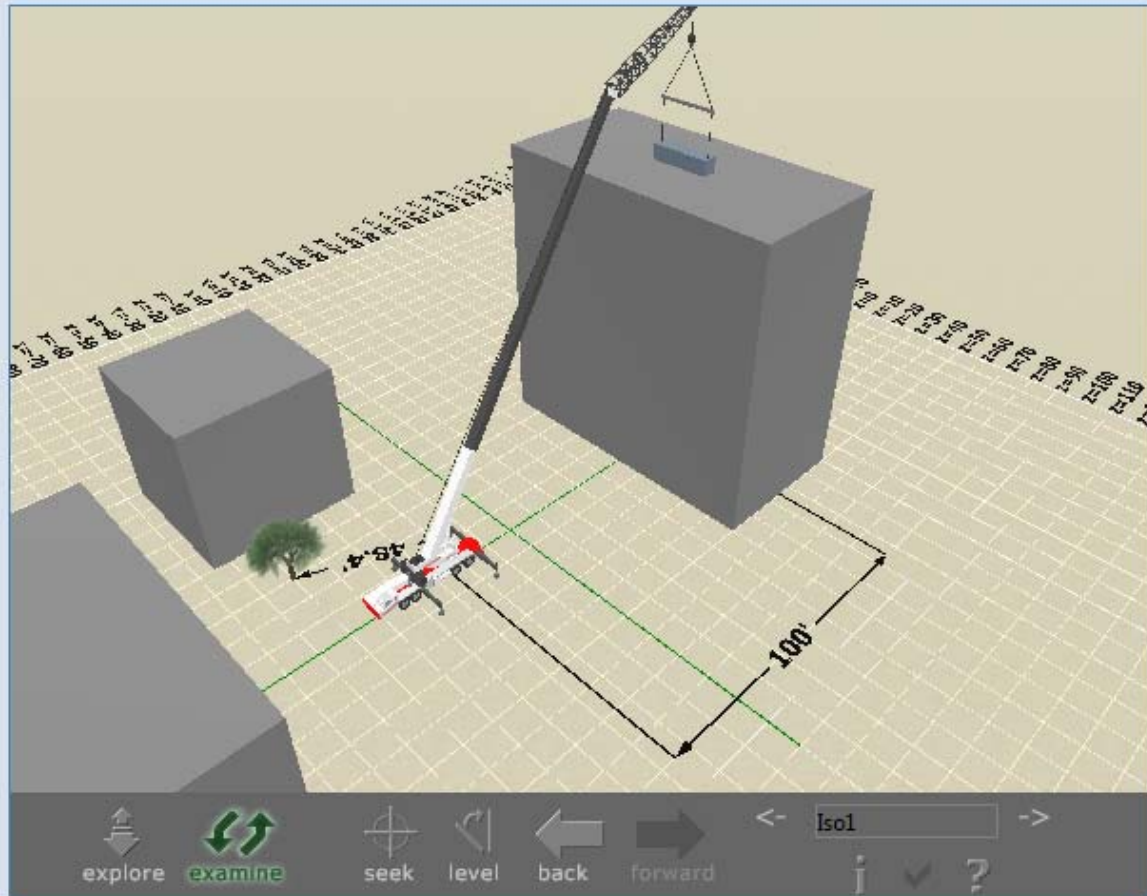

If you don't see a 3D image, [click here to install the Flux Player](#)

If you have problems viewing the 3D image, please visit our [Troubleshooting Page](#).

Snapshot Feature

Settings

Lift Plan Settings

Lift Setup

Quick Lift Setup
Load Type
Load Details
Rigging Type
Rigging Details
Advanced Rigging
Obstructions
Choose Crane
Multi-Crane

Crane Search

Search Setup
Search Cranes
Search Results

Lift Plan

Load Chart
Lift Simulation
Dimensions
Print
Export
Share

View:
Top

Snapshots

Set Point

Save Snapshot

1" = 0.08 ft
2" = 0.17 ft
3" = 0.25 ft
4" = 0.33 ft
5" = 0.42 ft
6" = 0.50 ft
7" = 0.58 ft
8" = 0.67 ft
9" = 0.75 ft
10" = 0.83 ft
11" = 0.92 ft

Lift Simulation

Link-Belt HTC-8690, Main Boom (Mode EM1), 35' Offset Fly, 100% Outriggers, CWT: 14500 lbs, 360°, 85% Capacity, D11P2127

Crane Configuration	
Center Pin X (ft): -25	Boom Length (ft): 140 (%s)
Center Pin Z (ft): 0	Boom Angle (°): 58.38
Crane Height (ft): 0	Jib Length (ft): 35
Carrier Angle (°): 0	Jib Offset (°): 30
Swing Angle (°): 0	Load Location (ft): X: 75 Y: 100 Z: 0
Hook Height (ft): 135.09	Load Angle/Rotation: A: 0 R: 0

Previous Page
Update
Print

Results	
Lift Radius (ft):	100
Tip Height (ft):	146.38
Net Load Weight (lbs):	5,000
Chart Capacity (lbs):	6,700

Refer to in-cab chart before lifting.

Configure your crane to the location radius and load location you would like using the Lift Simulation controls.

Type a Name for Snapshot (like Set Point).

Click "Save Snapshot" button

Re-Configure the crane for the next moment you would like to save in the lift.

Snapshot Feature Cont'd

Settings
Lift Plan Settings

Lift Setup
Quick Lift Setup
Load Type
Load Details
Rigging Type
Rigging Details
Advanced Rigging
Obstructions
Choose Crane
Multi-Crane

Crane Search
Search Setup
Search Cranes
Search Results

Lift Plan
Load Chart
Lift Simulation
Dimensions
Print
Export
Share

View:
Top

Snapshots
Open...
Open...
Set Point
Pick Point

1" = 0.08 ft
2" = 0.17 ft
3" = 0.25 ft
4" = 0.33 ft
5" = 0.42 ft
6" = 0.50 ft
7" = 0.58 ft
8" = 0.67 ft
9" = 0.75 ft
10" = 0.83 ft
11" = 0.92 ft

Lift Simulation
Link-Belt HTC-8690, Main Boom (Mode EM1), 35' Offset Fly, 100% Outriggers, CWT: 14500 lbs, 360°, 85% Capacity, D11P2127

Crane Configuration			
Center Pin X (ft): -25	<input type="button" value="-"/> <input style="width: 20px;" type="button" value="+"/>	Boom Length (ft): 140	<input type="button" value="(%'s)"/>
Center Pin Z (ft): 0	<input type="button" value="-"/> <input style="width: 20px;" type="button" value="+"/>	Boom Angle (°): 66.41	<input type="button" value="-"/> <input style="width: 20px;" type="button" value="+"/>
Crane Height (ft): 0	<input type="button" value="-"/> <input style="width: 20px;" type="button" value="+"/>	Jib Length (ft): 35	
Carrier Angle (°): 0	<input type="button" value="-"/> <input style="width: 20px;" type="button" value="+"/>	Jib Offset (°): 30	
Swing Angle (°): 90	<input type="button" value="-"/> <input style="width: 20px;" type="button" value="+"/>	Load Location (ft): X: -25 Y: -0.09 Z: 80	
Hook Height (ft): 35	<input type="button" value="-"/> <input style="width: 20px;" type="button" value="+"/>	Load Angle/Rotation: A: 0 R: 0	

Results	
Lift Radius (ft):	80
Tip Height (ft):	159.85
Net Load Weight (lbs):	5,000
Chart Capacity (lbs):	9,200

Refer to in-cab chart before lifting.

z=-100
z=-90
z=-80
z=-70
z=-60
z=-50
z=-40
z=-30
z=-20
z=-10
z=0
z=10
z=20
z=30
z=40
z=50
z=60
z=70
z=80
z=90
z=100
z=110
z=120
z=130
z=140
z=150
z=160
z=170

You can edit the name of the snapshot or delete them by clicking on the Snapshots link.

From the dropdown menu you will see the different snapshots you saved. When you select one the crane will be setup to the configuration you saved.

Manual Lift Video

To create a video you will need a couple other programs. Movie making software and a screen capture program. We use Windows Movie Maker software and Snagit screen capture software.

Steps to make a movie using Snagit and Windows Movie Maker:

1. Use the Snapshot feature to configure the crane throughout the lift you want to make the movie of.
2. Use Snagit to take screen captures of the images and save them into a folder. Make sure you name them in a series so you know where each image fits in the video.
3. Open Windows Movie Maker and drag each image into the slide show.

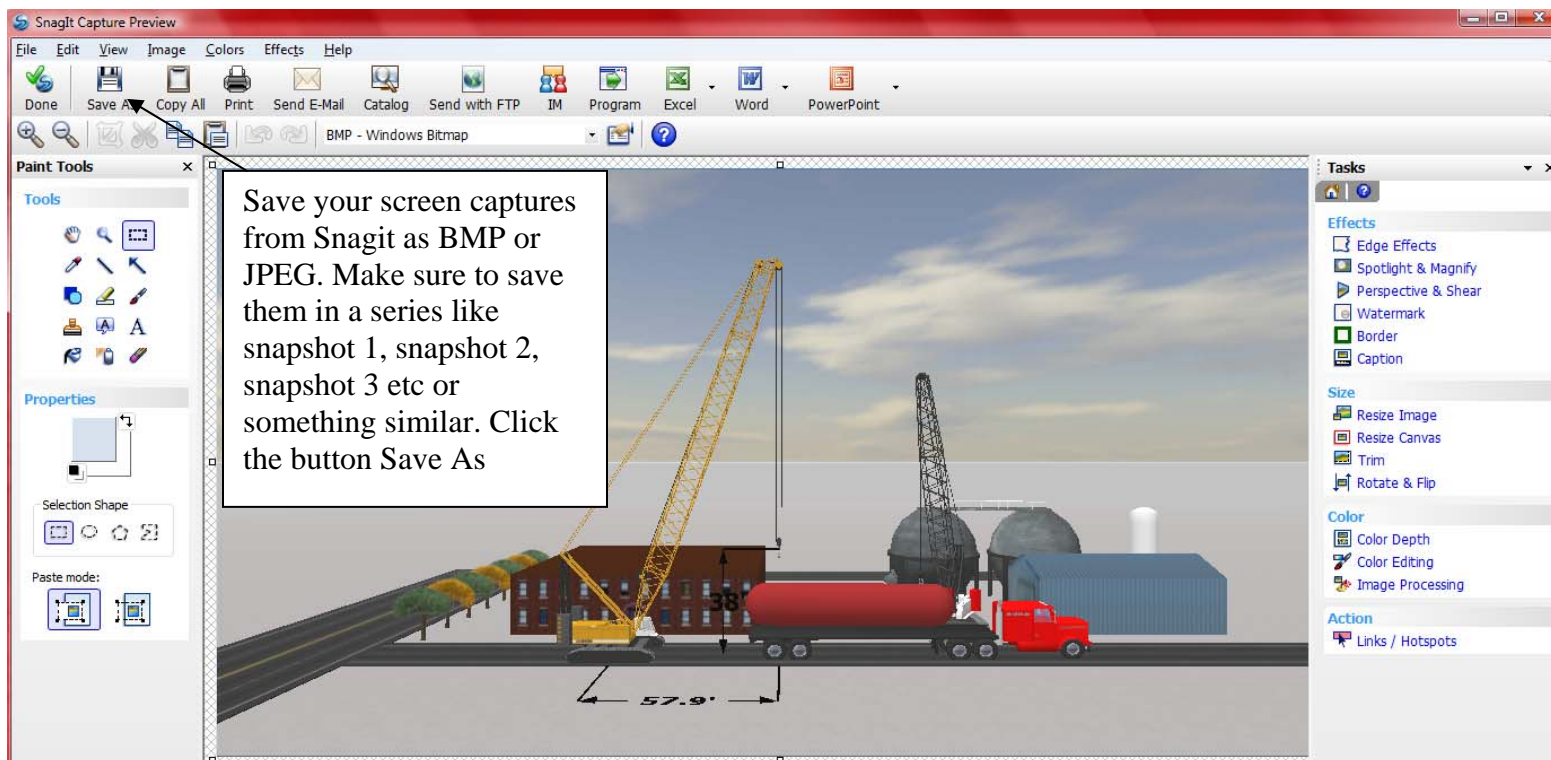

Manual Lift Video Cont'd

Click the link to import Pictures

Find the file you saved all your images from Snagit to.

Select all of the images and click the Import button

Manual Lift Video Cont'd

The screenshot shows the iMovie software interface. At the top, there is a menu bar with 'File', 'Edit', 'View', 'Tools', 'Clip', 'Play', and 'Help'. Below the menu bar, there are buttons for 'Import Media', 'AutoMovie', and 'Publish Movie'. The main workspace is divided into several sections:

- Tasks:** A sidebar on the left with categories like 'Import', 'Edit', and 'Publish to'. Under 'Import', there are options like 'From digital video camera', 'Videos', 'Pictures', and 'Audio or Music'. Under 'Edit', there are options like 'Imported media', 'Effects', 'Transitions', and 'Titles and credits'. Under 'Publish to', there are options like 'This computer', 'Recordable CD', 'E-mail', and 'Digital video camera'.
- Imported media table:** A table with columns: 'Clip Name', 'Duration', 'Start Time', 'End Time', 'Dimensions', 'Date Taken', and 'File N'. It lists 12 clips, with clip 12 named 'PickPoint'.
- Timeline:** A horizontal bar at the bottom showing a sequence of video clips. The first clip is selected, and a callout box says 'Click and drag to trim the clip'.
- Preview window:** A large window on the right showing a 3D rendering of a construction site with a crane and a truck.

Two callout boxes provide instructions:

- Box 1: 'Hold your left mouse button down on each picture and drag them into the video clip below' (pointing to the 'Imported media' table).
- Box 2: 'Hold your mouse over the end of each image and hold you left mouse key down and drag to the time that you want each slide to play.' (pointing to the end of a clip on the timeline).

Manual Lift Video Cont'd

Tasks

Import

- From digital video camera
- Videos
- Pictures
- Audio or Music

Edit

- Imported media
- Effects
- Transitions
- Titles and credits**

Publish to

- This computer
- Recordable CD
- E-mail
- Digital video camera

You can add text to your video by clicking on Titles and Credits link.

Select whether you want a title page at the beginning of your movie, place text over an image, add a page with text during the movie or add a credits page at the end of the movie.

Where do you want to add a title?

- Title at the beginning**
- Title before the selected clip
- Title on the selected clip
- Credits at the end

Cancel

When you are done with making the video click the link to publish the video, usually you would use This Computer link. Give it a name and save it. That's all there is to it.

Tasks

Import

- From digital video camera
- Videos
- Pictures
- Audio or Music

Edit

- Imported media
- Effects
- Transitions
- Titles and credits

Publish to

- This computer**
- Recordable CD
- E-mail
- Digital video camera

Technical Support FAQ's and Information

Q. I can't see any images of the crane or jobsite

A. Make sure you have the minimum requirements (refer to page 6), make sure you have installed the flux player correctly, allow ActiveX controls to run (you will see a yellow bar at the top of your screen), make sure you are using internet explorer.

Q. When I run crane selection no cranes are found to do the lift.

A. Make sure you have added cranes to your account (refer to page 11-12.) If that is not the issue, go to the Search Setup page and make sure you have the information filled out correctly (refer to page 29.)

Q. I can't get the printing program to open.

A. Double check to see if there is a yellow bar towards the top of the screen that asks you to install and ActiveX control. Make sure the security settings on your computer are not set higher than medium high. Make sure you are using Internet Explorer. If you are still having issues with printing contact us at support@3dliftplan.com.

Upcoming Features

Tower Crane Erection/ Dismantle Wizard

Collision Detection

Additional Rigging Types

Ground Bearing Pressures under Your Timber Mats

Multiple Load Pickup and Drop Off

Parts of Line Calculator

Lift Video

Project Management

Thank you for using 3D Lift Plan. If you have any comments or suggestions or you need help at any time please feel free to contact us by phone at (904) 430-0355 or by email at support@3dliftplan.com.